

JVC



English

DVD DIGITAL CINEMA SYSTEM
SYSTEMA DVD DIGITAL CINEMA
SISTEMA DE CINEMA DE DVD DIGITAL

TH-M65

Consists of XV-THM65, SP-PWM65, SP-THM65C and SP-THM65F

Consta de XV-THM65, SP-PWM65, SP-THM65C y SP-THM65F

Consiste em XV-THM65, SP-PWM65, SP-THM65C e SP-THM65F

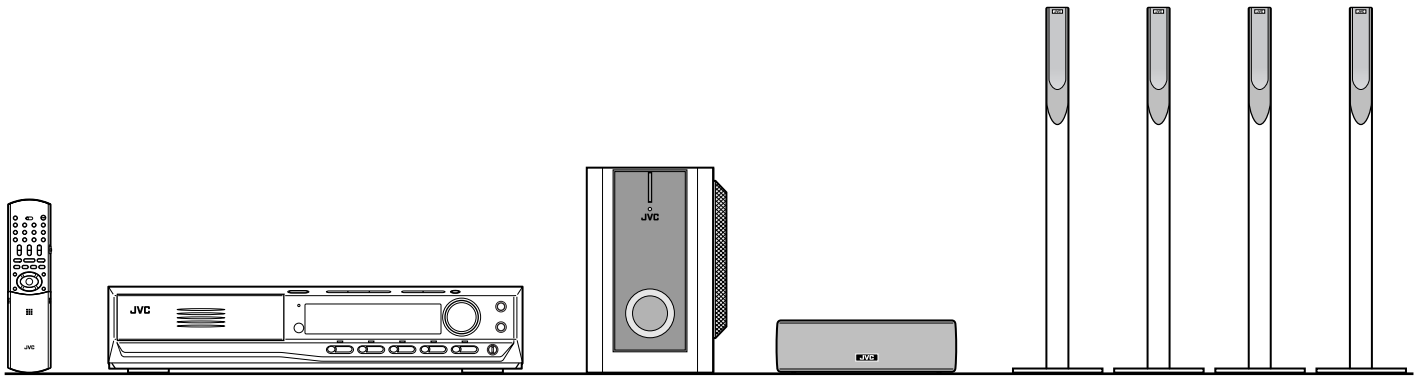

Español

Português

TH-M45

Consists of XV-THM45, SP-PWM45, SP-THM45C, SP-THM45F and SP-THM45S

Consta de XV-THM45, SP-PWM45, SP-THM45C, SP-THM45F y SP-THM45S

Consiste em XV-THM45, SP-PWM45, SP-THM45C, SP-THM45F e SP-THM45S

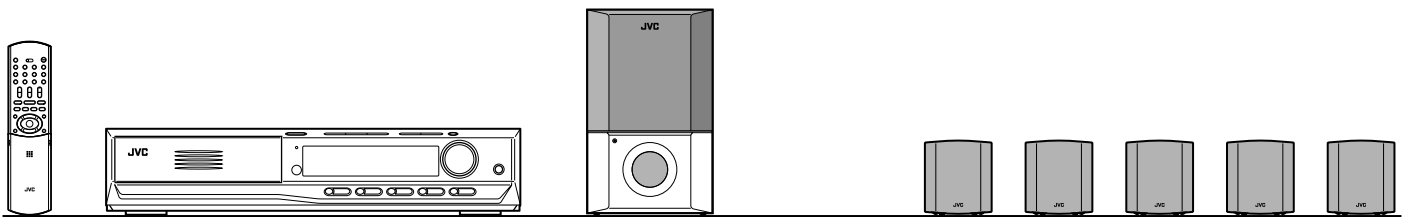

AV COMPU LINK *Digital Direct Progressive Scan*

INSTRUCTIONS
MANUAL DE INSTRUCCIONES
INSTRUÇÕES

Warnings, Cautions and Others / Avisos, precauciones y otras notas / Advertências, precauções e outras notas

CAUTION

To reduce the risk of electrical shocks, fire, etc.:

1. Do not remove screws, covers or cabinet.
2. Do not expose this appliance to rain or moisture.

PRECAUTION

Para reducir el riesgo de descargas eléctricas, fuego, etc.:

1. No quitar los tornillos, tapas o caja.
2. No exponer el aparato a la lluvia ni a la humedad.

PRECAUÇÃO

Para reduzir o riscos de choques elétricos, incêndio, etc.:

1. Não retire parafusos nem desmonte as tampas ou o gabinete.
2. Não exponha este aparelho à chuva nem à umidade.

CAUTION – \odot /I button! (XV-THM65/XV-THM45)

Disconnect the mains plug to shut the power off completely (the STANDBY lamp goes off).

The \odot /I button in any position does not disconnect the mains line.

- When the system is on standby, the STANDBY lamp lights red.
- When the system is turned on, the STANDBY lamp goes off. The power can be remote controlled.

PRECAUCIÓN – Botón \odot /I! (XV-THM65/XV-THM45)

Para desactivar la alimentación completamente, desenchufe el cable de alimentación de CA (lámpara STANDBY se apaga).

La línea de la red no se desconecta en ninguna de las posiciones del botón \odot /I.

- Cuando el sistema se encuentra en standby, lámpara STANDBY se enciende en rojo.
- Cuando se activa la alimentación del sistema, la lámpara STANDBY se apaga.

La alimentación puede ser controlada a distancia.

PRECAUÇÃO – botão \odot /I! (XV-THM65/XV-THM45)

Desligue a ficha principal da parede para desligar totalmente a energia (a lâmpada STANDBY apaga-se).

O botão \odot /I em qualquer posição não desliga o cabo principal.

- Quando o sistema está em espera, a luz da lâmpada STANDBY fica vermelha.
- Quando o sistema está ligado, a lâmpada STANDBY apaga-se.

A energia pode ser controlada à distância.

CAUTION (SP-PWM65/SP-PWM45)

The power supply to the subwoofer is linked to the center unit. The POWER ON lamp on the subwoofer lights green when the power is turned on.

PRECAUCIÓN (SP-PWM65/SP-PWM45)

El suministro de energía al altavoz de subgraves está vinculado a la unidad central. La lámpara POWER ON del altavoz de subgraves se enciende en verde al encenderse el sistema.

PRECAUÇÃO (SP-PWM65/SP-PWM45)

O fornecimento de energia ao subwoofer está vinculado à unidade central. A lâmpada POWER ON do subwoofer acende-se em verde quando a alimentação está ligada.

IMPORTANT FOR LASER PRODUCTS / IMPORTANTE PARA LOS PRODUCTOS LÁSER / IMPORTANTE PARA PRODUCTOS LASER

REPRODUCTION OF LABELS / REPRODUCCIÓN DE ETIQUETAS / REPRODUÇÃO, DE ETIQUETAS

CLASSIFICATION LABEL, PLACED ON EXTERIOR
SURFACE

ETIQUETA DE CLASIFICACION, PROVISTA SOBRE LA
SUPERFICIE EXTERIOR

ETIQUETA DE CLASSIFICACAO, COLOCADA EM
SUPERFICIE EXTERNA

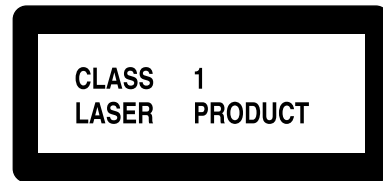

WARNING LABEL, PLACED INSIDE THE UNIT

ETIQUETA DE ADVERTENCIA, PEGADA EN EL INTERIOR
DE LA UNIDAD

ETIQUETA DE ADVERTÊNCIA LOCALIZADA NA PARTE
INTERNA DA UNIDADE

CAUTION : Visible and invisible laser radiation when open and interlock failed or defeated. AVOID DIRECT EXPOSURE TO BEAM.	ADVARSEL : Synlig og usynlig laserstråling når maskinen er åben eller interlocken fejler. Undgå direkte eksponering til stråling.	WARNING : Synlig och osynlig laserstråling när den öppnas och spärren är urkopplad. Betrakta ej strålen.	VARO : Avattaessa ja suojalukitus ohjeltuna tai viälisena olet allittuna näkyvälle ja näkymättömälle lasersäteilylle. Vältä säteen kohdistumista suoraan itseesi. (f)
---	--	---	--

1. CLASS 1 LASER PRODUCT
2. **CAUTION**: Visible and invisible laser radiation when open and interlock failed or defeated. Avoid direct exposure to beam.
3. **CAUTION**: Do not open the top cover. There are no user serviceable parts inside the Unit; leave all servicing to qualified service personnel.

1. PRODUCT LASER CLASE 1
2. **PRECAUCIÓN**: Radiación láser visible e invisible al abrir, o al fallar o ignorar los cierres de seguridad. Evite la exposición directa a los haces.
3. **PRECAUCIÓN**: No abra la tapa superior. En el interior de la unidad no existen piezas reparables por el usuario; deje todo servicio técnico en manos de personal calificado.

1. PRODUCTO LASER CLASSE 1
2. **PRECAUÇÃO**: Radiação laser visível e invisível quando aberto e bloqueio falhou ou avariou. Evite exposinao direta ao feixe dos raios.
3. **PRECAUÇÃO**: Não abra a caixa do aparelho. Não existem peças reparáveis pelo usuário na parte interna da unidade. Solicite assistência técnica somente a pessoal técnico qualificado.

CAUTION

- Do not block the ventilation openings or holes. (If the ventilation openings or holes are blocked by a newspaper or cloth, etc., the heat may not be able to get out.)
- Do not place any naked flame sources, such as lighted candles, on the apparatus.
- When discarding batteries, environmental problems must be considered and local rules or laws governing the disposal of these batteries must be followed strictly.
- Do not expose this apparatus to rain, moisture, dripping or splashing and that no objects filled with liquids, such as vases, shall be placed on the apparatus.

PRECAUCIÓN

- No obstruya las rendijas o los orificios de ventilación. (Si las rendijas o los orificios de ventilación quedan tapados con un periódico, un trozo de tela, etc., no se podrá disipar el calor).
- No ponga sobre el aparato ninguna llama al descubierto, como velas encendidas.
- Cuando tenga que descartar las pilas, tenga en cuenta los problemas ambientales y observe estrictamente los reglamentos o las leyes locales sobre disposición de las pilas.
- No exponga este aparato a la lluvia, humedad, goteos o salpicaduras. Tampoco ponga recipientes conteniendo líquidos, como floreros, encima del aparato.

PRECAUÇÃO

- Não obstrua as aberturas e orifícios de ventilação. (Se orifícios ou aberturas de ventilação estiverem obstruídos por qualquer papel ou tecido, não haverá circulação do ar quente.)
- Não coloque nenhum objeto com chamas, como velas acesas, sobre o aparelho.
- Ao descartar as baterias, leve em consideração os problemas que possam ser causados ao meio ambiente e os regulamentos e leis locais e governamentais sobre recolhimento dessas baterias devem ser rigorosamente seguidos.
- Não exponha este aparelho à chuva, umidade, pingos ou esguichos de água, nem coloque em cima do mesmo qualquer tipo de recipiente que contenha líquidos, como por exemplo vasos.

Caution: Proper Ventilation

To avoid risk of electric shock and fire and to protect from damage, place the apparatus on a level surface. The minimal clearances are shown below:

Precaución: Ventilación Adecuada

Para evitar riesgos de descargas eléctricas e incendios y para protegerlo contra los daños, coloque el aparato sobre una superficie estable. Las holguras mínimas se indican a continuación:

Precaução: ventilação apropriada

Para evitar o risco de choque eléctrico e incêndio e prevenir avarias, coloque o aparelho em superfície nivelada. Os espaços mínimos necessários encontram-se abaixo:

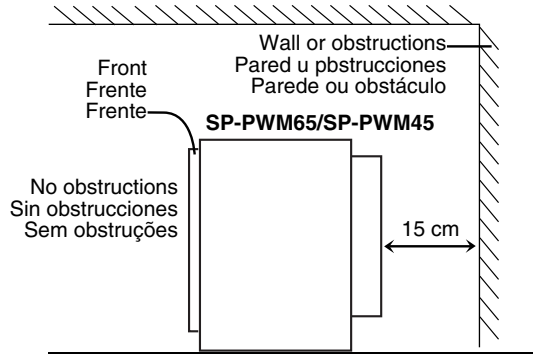
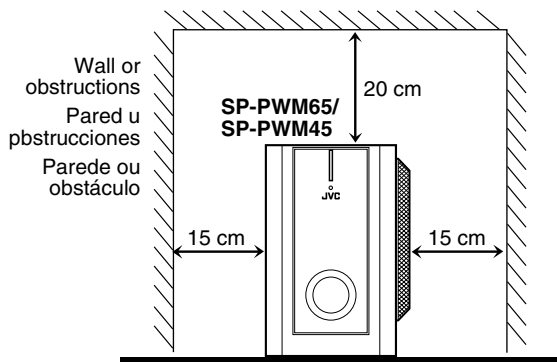
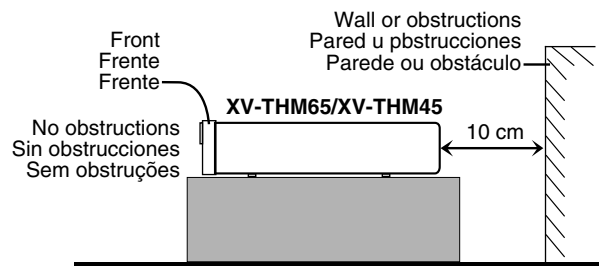
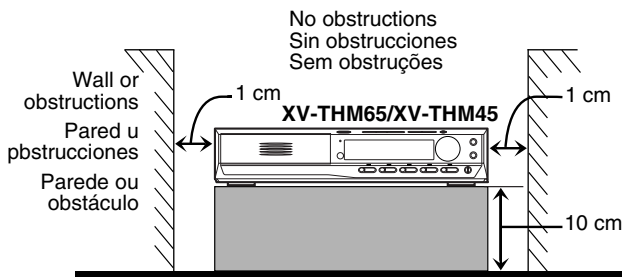

Table of contents

Introduction.....	2	Creating realistic sound fields	29
Notes on handling	2	Using the surround mode	31
Supplied accessories	2	Adjusting the sound.....	32
About discs	3	Advanced operations	33
Playable disc types	3	Using the on-screen bar	33
Disc structure	4	Playing from a specified position on a disc.....	34
Playback Control function (PBC) — VCD and SVCD only	4	Using the MP3 control display.....	36
Names of parts and controls	5	Using the JPEG control display.....	37
Getting started.....	8	Selecting a view angle of DVD	38
Connections	8	Selecting the subtitle/audio languages.....	39
Using the remote control	16	Special picture playback	41
Basic operations	19	Program Playback.....	43
Turning the system on/off.....	19	Random Playback.....	44
Selecting the source to play	20	Repeat Playback	44
Adjusting the volume	20	Setting DVD preferences	46
Listening with headphones (TH-M45 only)	20	Using the choice menus	46
Turning off the sound temporarily	20	Menu description.....	48
Adjusting the brightness	20	Parental Lock.....	51
Using the Sleep Timer.....	21	System setting	54
Adjusting the output level of the subwoofer.....	21	AV COMPU LINK remote control	
Adjusting the bass/treble sound.....	21	system	55
Changing the decode mode	22	KARAOKE operations	
Changing the scan mode	22	(TH-M65 only)	56
Playback	23	Basic KARAOKE operation	56
Basic playback	23	Reserving songs	57
Playback features	25	Selecting audio	58
Tuner operations.....	27	Adding an effect to your voice	60
Setting the AM tuner interval spacing	27	Shifting the pitch of the playback sound.....	61
Manual tuning	27	References	62
Preset tuning	27	Maintenance	62
Selecting the FM reception mode.....	28	Trouble shooting.....	62
Reducing the noise of AM broadcast	28	Glossary.....	65
		Index.....	66
		Specifications	67

Notes on handling

■ Important cautions

Installation of the system

- Select a place which is level, dry and neither too hot nor too cold; between 5°C and 35°C (41°F and 95°F).
- Leave sufficient distance between the system and the TV.
- Do not use the system in a place subject to vibration.

Power cord

- Do not handle the power cord with wet hands!
- A small amount of power (1.6 watts) is always consumed while the power cord is connected to the wall outlet (center unit only).
- When unplugging the power cord from the wall outlet, always pull on the plug, not the power cord.

To prevent malfunctions of the system

- There are no user-serviceable parts inside. If anything goes wrong, unplug the power cord and consult your dealer.
- Do not insert any metallic object into the system.
- Do not use any non-standard shape disc (like a heart, flower or credit card, etc.) available on the market, because it may damage the system.
- Do not use a disc with tape, stickers, or paste on it, because it may damage the system.

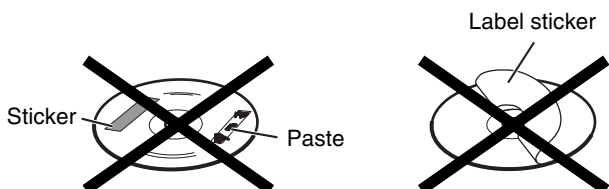

Note about copyright laws

Check the copyright laws in your country before recording from DVDs, Super Video CDs (SVCs), Video CDs (VCDs) and Audio CDs. Recording of copyrighted material may infringe copyright laws.

Note about copyguard system

DVDs are protected by copyguard system. When you connect the system to your VCR directly, the copyguard system activates and the picture may not be played back correctly.

■ Safety precautions

Avoid moisture, water and dust

Do not place the system in moist or dusty places.

Avoid high temperatures

Do not expose the system to direct sunlight and do not place it near a heating device.

When you are away

When away on travel or for other reasons for an extended period of time, disconnect the power cord plug from the wall outlet.

Do not block the vents

Blocking the vents may damage the system.

Care of the cabinet

When cleaning the system, use a soft cloth and follow the relevant instructions on the use of chemically-coated cloths. Do not use benzene, thinner or other organic solvents including disinfectants. These may cause deformation or discoloring.

If water gets inside the system

Turn the system off and disconnect the power cord plug from the wall outlet, then call the store where you made your purchase. Using the system in this condition may cause fire or electrical shock.

Supplied accessories

Check to be sure you have all of the supplied accessories. The number in parentheses is the quantity of the pieces supplied. If anything is missing, contact your dealer immediately.

- Remote control (1)
- Batteries (2)
- FM antenna (1)
- AM loop antenna (1)
- Power cord (1)
- System cord (1)
- Composite video cord (1)
- Speaker cords
 - 5 m: For satellite (front left/right) and center speakers (3)
 - 10 m: For satellite speakers (surround left/right) (2)
(Length of speaker cords is approximate.)
- Screws (with washer) (TH-M65 only)
 - M4 x 25 mm: For satellite speakers (16)
- AC plug adaptor (2)

This product incorporates copyright protection technology that is protected by method claims of certain U.S. patents and other intellectual property rights owned by Macrovision Corporation and other rights owners. Use of this copyright protection technology must be authorized by Macrovision Corporation, and is intended for home and other limited viewing uses only unless otherwise authorized by Macrovision Corporation. Reverse engineering or disassembly is prohibited.







About discs

Playable disc types

This system has been designed to play back the following discs: DVD Video (DVD), Video CD (VCD), Super Video CD (SVCD), Audio CD, CD-R and CD-RW.

- This system can also play back MP3 and JPEG files recorded on CD-Rs and CD-RWs. (☞ pg. 23)
- This system can also play back finalized DVD-Rs recorded in DVD VIDEO format. However, some discs may not be played back because of their disc characteristics or recording conditions.

Discs you can play:

Disc Type	Mark (Logo)	Video Format	Region Code Number*
DVD		NTSC/ PAL	4/ALL
VCD		NTSC/ PAL	—
SVCD		NTSC/ PAL	—
Audio CD		—	—
CD-R		—	—
CD-RW		—	—

* Note on Region Code

DVD players and DVDs have their own Region Code numbers. This system can only play back DVDs recorded with the color system of NTSC or PAL whose Region Code number includes "4".

Examples:



If a DVD with an improper Region Code number is loaded, "REGION CODE ERROR!" appears on the TV screen and playback cannot start.

- The following discs cannot be played back: DVD Audio, DVD-ROM, DVD-RAM, DVD-RW, CD-ROM, CD-I (CD-I Ready), Photo CD, etc. Playing back these discs will generate noise and damage the speakers.
- **On some DVDs, Video CDs or SVCDs, their actual operation may be different from what is explained in this manual. This is due to the disc programming and disc structure, not a malfunction of this system.**

Notes on CD-R and CD-RW

- User-edited CD-Rs (Recordable) and CD-RWs (Rewritable) can be played back only if they are already "finalized".
- This system can play back CD-Rs or CD-RWs recorded on a personal computer if they have been recorded in the audio CD format. This system can also play back CD-Rs or CD-RWs if MP3 files or JPEG files are recorded on them. However, some discs may not be played back because of their disc characteristics, recording conditions, or damage or stain on them.

Especially, the configuration and characteristics of an MP3 disc or a JPEG disc are determined by the writing (encoding) software and hardware used for recording. Therefore, due to the software and hardware used, the following symptoms may occur:

- Some discs may not be played back.
- Some tracks on an MP3 disc may be skipped or may not be played back normally.
- Some files on a JPEG disc may be played back distortedly.
- Before playing back CD-Rs or CD-RWs, read their instructions or cautions carefully.
- CD-RWs may require a longer readout time. This is caused by the fact that the reflectance of CD-RWs is lower than that of regular CDs.

About MP3 discs

MP3 is an abbreviation for Motion Picture Experts Group 1 (or MPEG-1) Audio Layer 3. MP3 is simply a compressed data file format. By using MP3 format, one CD-R or CD-RW can contain 10 times as much data as one regular CD.

About JPEG discs

A still-picture data compression system proposed by the Joint Photographic Expert Group, which features small decrease in image quality in spite of its high compression ratio.

Notes on MP3/JPEG discs

- MP3/JPEG discs (either CD-R or CD-RW) require a longer readout time. (It differs due to the complexity of the directory/file configuration.)
- When making an MP3/JPEG disc, select ISO 9660 Level 1 or Level 2 for the disc format.
- This system supports "multi-session" discs (up to 5 sessions).
- This system cannot play "packet write" discs.
- The system can only play MP3/JPEG files with the following file extensions; MP3: ".MP3", ".Mp3", ".mp3" and ".mp3" JPEG: ".jpg", ".jpeg", ".JPG", ".JPEG" and any uppercase and lowercase combination (such as ".Jpg")
- If both MP3 files and JPEG files are recorded on a disc, set the MP3/JPEG setting in the PICTURE menu to the appropriate setting for the data to be read ("MP3" or "JPEG"). (☞ pg. 49)
- Some MP3/JPEG discs may not be played back because of their disc characteristics or recording conditions.

Notes on MP3 discs only

- ID3* tags cannot be shown on the display.
 - * An MP3 file can contain file information called an "ID3 Tag" where its album name, performer, track title, etc. are recorded. There are two versions, ID3v1 (ID3 Tag version 1) and ID3v2 (ID3 Tag version 2).
- We recommend to record each piece of material (song) at a sample rate of 44.1 kHz and at a data transfer rate of 128 kbps.
- Some tracks on an MP3 disc may be skipped or may not be played back normally.

Notes on JPEG discs only

- We recommend to record a file at 640 x 480 resolution. (If a file has been recorded at a resolution of more than 640 x 480, it will take a longer time to be displayed.)
- This system can only play baseline JPEG files*. Progressive JPEG files* or lossless JPEG files* cannot be played.
 - * Baseline JPEG format: Used for digital cameras, web, etc.
 - Progressive JPEG format: Used for web.
 - Lossless JPEG format: An old type and rarely used now.
- Some files on a JPEG disc may be played back distortedly.

IMPORTANT

Before playing a disc, make sure of the following;

- Check the connection with the TV.
- Turn on your TV and select the correct input mode on the TV to view the pictures or on-screen information on the TV screen.
- For DVD playback, you can change the initial setting to your preference. (☞ pg. 46 – 53)

If Ⓞ appears on the TV screen when pressing a button;

The disc cannot accept the operation you have tried to do, or the information required for that operation is not recorded on the disc.

NOTICE: In some cases, without showing Ⓞ, operations will not be accepted.

Disc structure

DVD

A DVD consists of “titles” and each title may be divided into “chapters”.

For example, if a DVD contains movies, each movie may have its own title number and may be further divided into chapters.

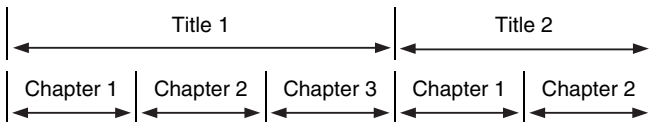

Video CD/SVCD/Audio CD

A Video CD, SVCD, Audio CD consists of “tracks”.

In general, each track has its own track number. (On some discs, each track may also be further divided by indexes.)

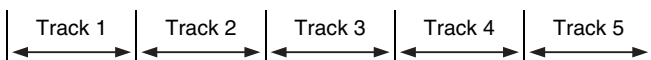

MP3 discs

On an MP3 disc, each song is recorded as a track (file). Tracks are usually grouped into a group (folder). Groups can also include other groups, creating hierarchical group layers. This system can recognize up to 150 tracks per group and up to 99 groups per disc.

- If there is any type of file other than MP3 files in a group (folder), those files are also counted in the total number of 150.

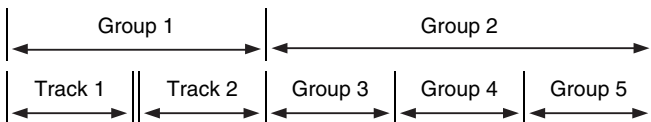

JPEG discs

On a JPEG disc, each still picture is recorded as a file. Files are usually grouped into a group (folder). Groups can also include other groups, creating hierarchical folder layers. This system can recognize up to 150 files per group and up to 99 groups per disc.

- If there is any type of file other than JPEG files in a group (folder), those files are also counted in the total number of 150.

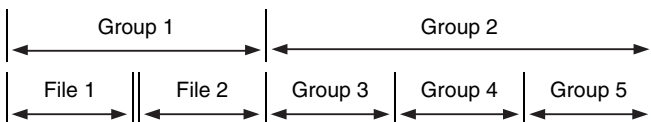

Playback Control function (PBC) — VCD and SVCD only

The Playback Control function allows you to enjoy menu-driven operation and high-resolution still images which have a resolution four times greater than moving pictures.

High-resolution still image display

You can display high-quality images which are four times clearer than moving pictures.

Menu-driven playback

A selection menu is displayed when you start playing a Video CD or SVCD with the Playback Control feature. The selection menu shows a list of numbers for selection. Some discs may show moving pictures or a divided screen.

You can interact with the screen using a menu display to select and play an entry.

See example illustration below about basic features of menu-driven playback (for details about the operation through the menu, also see page 35).

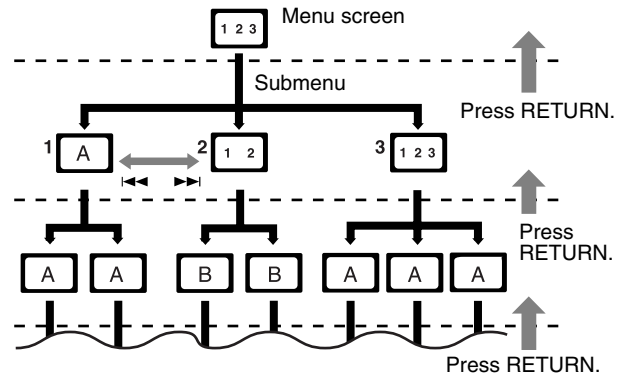

A: Moving picture
B: Still picture

NOTE

- When operating a Video CD or SVCD using the menu, some functions such as Repeat Playback may not work.

Names of parts and controls

The illustrations of the center unit and the subwoofer used in this manual are of TH-M65 unless otherwise noted.

Front panel (center unit)

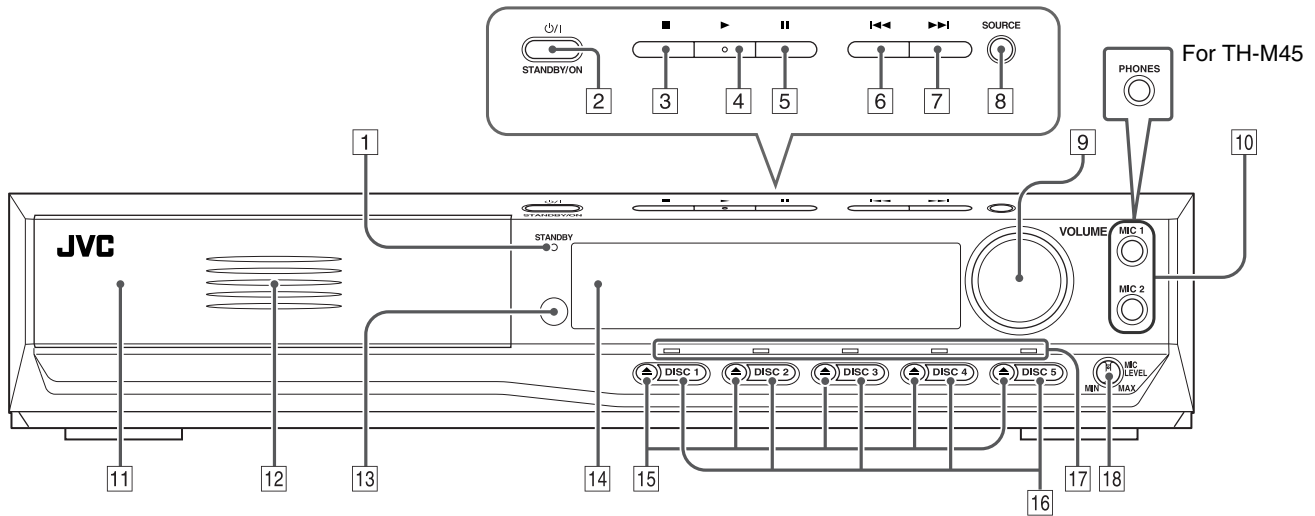

- | | |
|--|---|
| <ul style="list-style-type: none"> 1 Standby lamp (STANDBY) ☞ pg. 19 2 Standby-on button (⏻/STANDBY/ON) ☞ pg. 19 3 Stop button (■) ☞ pg. 23 4 Play button (▶) ☞ pg. 23 5 Pause button (⏸) ☞ pg. 23 6 Reverse skip button (◀◀) ☞ pg. 26 7 Forward skip button (▶▶) ☞ pg. 26 8 Source button (SOURCE) ☞ pg. 20 9 Volume control (VOLUME) ☞ pg. 20 | <ul style="list-style-type: none"> 10 Microphone jacks (MIC 1/2) (TH-M65) ☞ pg. 56 Headphones jack (PHONES) (TH-M45) ☞ pg. 20 11 Disc trays ☞ pg. 23 12 Illumination lamp ☞ pg. 20 13 Remote sensor ☞ pg. 16 14 Display window ☞ pg. 6, 24 15 Open/close buttons (▲) ☞ pg. 23 16 Disc buttons (DISC 1-5) ☞ pg. 23 17 Disc lamps (TH-M65 only) ☞ pg. 25 18 Microphone level control (MIC LEVEL) (TH-M65 only) ☞ pg. 56 |
|--|---|

Rear panel (center unit)

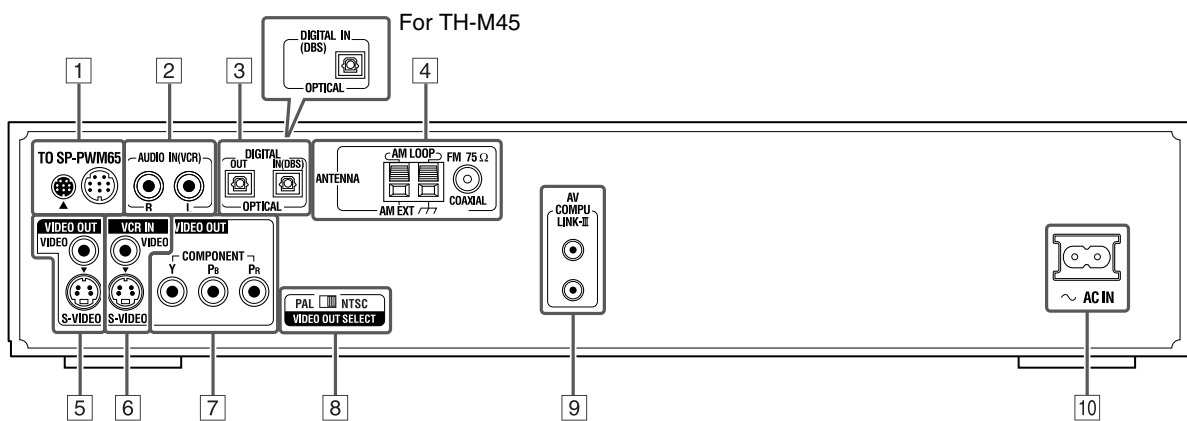

- | | |
|--|--|
| <ul style="list-style-type: none"> 1 System cord connector ☞ pg. 10 2 Audio input jacks (AUDIO IN (VCR)) ☞ pg. 14 3 Digital input/output jacks (DIGITAL IN/OUT) (TH-M65) ☞ pg. 14 Digital input jack (DIGITAL IN) (TH-M45) ☞ pg. 14 4 Antenna terminals (ANTENNA) ☞ pg. 9 | <ul style="list-style-type: none"> 5 Video output jacks (VIDEO OUT) ☞ pg. 8 VIDEO, S-VIDEO 6 Video input jacks (VCR IN) ☞ pg. 14 VIDEO, S-VIDEO 7 Video output jacks (VIDEO OUT) ☞ pg. 8 COMPONENT (Y, PB, PR) 8 Video output signal switch (VIDEO OUT SELECT) ☞ pg. 8 PAL, NTSC 9 AV COMPU LINK-III jacks ☞ pg. 55 10 ~ AC IN socket ☞ pg. 15 |
|--|--|

Display window (center unit)

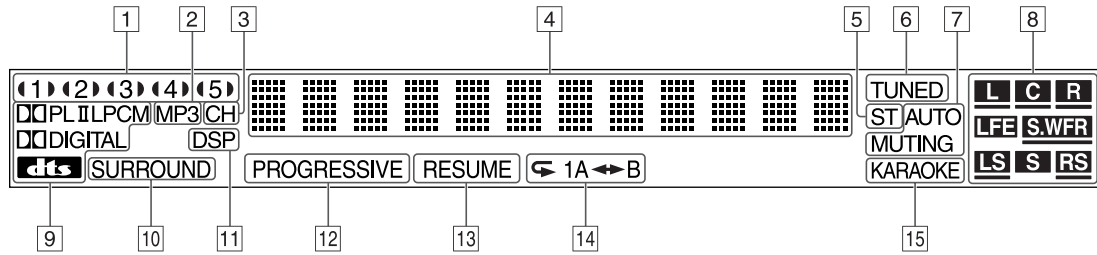

- 1 Disc indicators ☞ pg. 25
- 2 MP3 indicator ☞ pg. 24
- 3 Channel indicator (CH) ☞ pg. 28
- 4 Main display ☞ pg. 24
- 5 Stereo indicator (ST) ☞ pg. 27
- 6 Tuning indicator (TUNED) ☞ pg. 27
- 7 Auto muting indicator (AUTO MUTING) ☞ pg. 28
- 8 • Source signal indicators (**L C R LFE LS S RS**) ☞ pg. 30
 - Subwoofer indicator (**S.WFR**) ☞ pg. 30
 - Sound reproducing speaker indicator (**_**) ☞ pg. 30
- 9 • Dolby Pro Logic II indicator (**PLII**) ☞ pg. 29
 - Linear PCM indicator (LPCM) ☞ pg. 30
 - Digital signal format indicators ☞ pg. 30
 - Dolby Digital (**DIGITAL**), DTS (**DTS**)
- 10 Surround indicator (SURROUND) ☞ pg. 31
- 11 DSP indicator ☞ pg. 29 – 31
- 12 Progressive mode indicator (PROGRESSIVE) ☞ pg. 22
- 13 Resume indicator (RESUME) ☞ pg. 24
- 14 Repeat mode indicators ☞ pg. 44
- 15 Karaoke indicator (KARAOKE) (TH-M65 only) ☞ pg. 56

Powered subwoofer

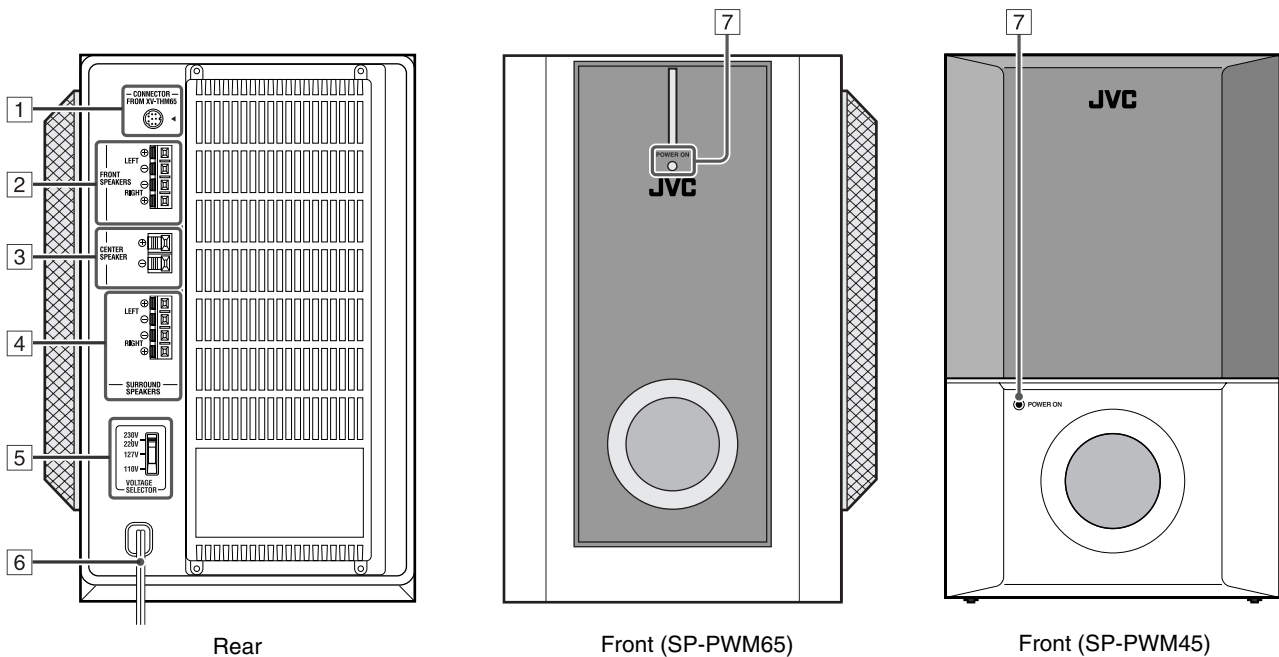

- 1 System cord connector ☞ pg. 10
- 2 Front speaker terminals (FRONT SPEAKERS) ☞ pg. 12, 13
- 3 Center speaker terminals (CENTER SPEAKER) ☞ pg. 12, 13
- 4 Surround speaker terminals (SURROUND SPEAKERS) ☞ pg. 12, 13
- 5 Voltage selector switch (VOLTAGE SELECTOR) ☞ pg. 15
- 6 Power cord ☞ pg. 15
- 7 Power lamp (POWER ON) ☞ pg. 19

Names of parts and controls

Remote control

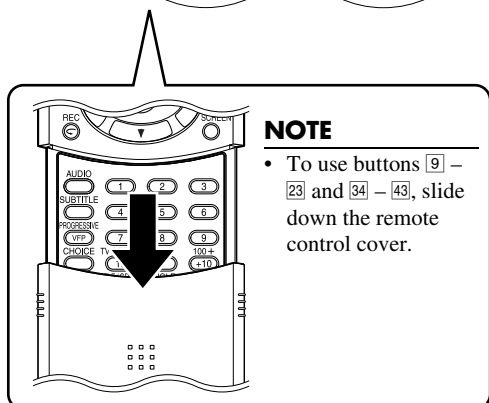
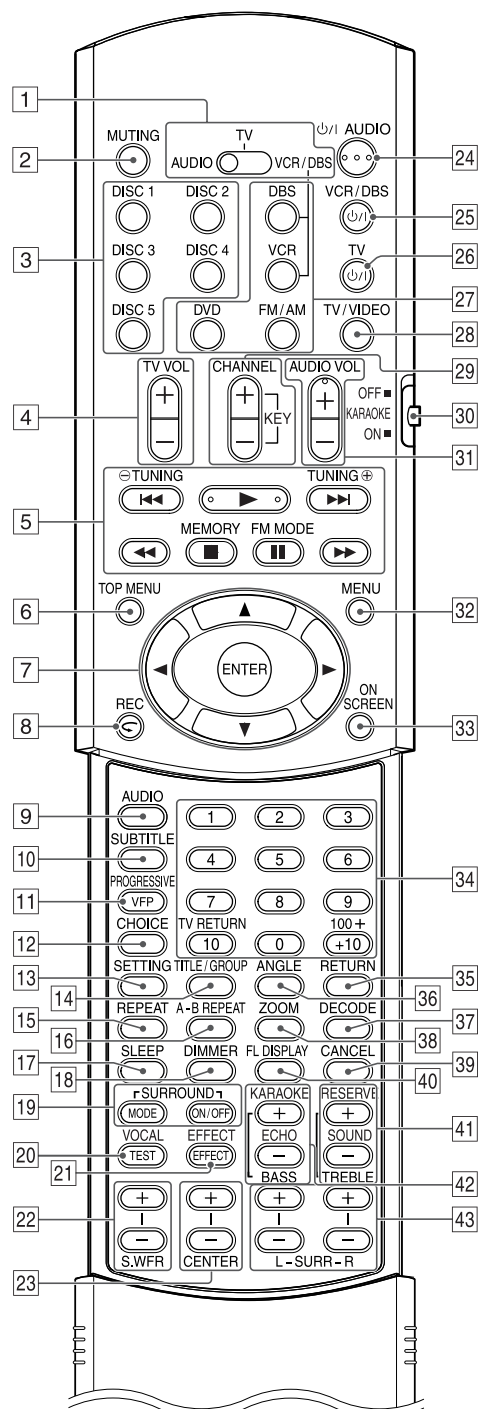

- 1 Remote control mode selector ☞ pg. 17 - 54
AUDIO, TV, VCR/DBS
- 2 Muting button (MUTING) ☞ pg. 20
- 3 Disc buttons (DISC 1-5) ☞ pg. 23
- 4 TV volume buttons (TV VOL +/-) ☞ pg. 17
- 5 Operating buttons
 - Play button (▶) ☞ pg. 24
 - Forward/reverse skip buttons (▶▶/◀◀) ☞ pg. 26
 - Fast-forward/reverse playback buttons (▶▶/◀◀) ☞ pg. 26
 - Stop button (■) ☞ pg. 23
 - Pause button (⏸) ☞ pg. 23
 - Tuning buttons (TUNING ⊕, TUNING ⊖) ☞ pg. 27
 - Memory button (MEMORY) ☞ pg. 28
 - FM reception/Beat Cut mode button (FM MODE) ☞ pg. 28
- 6 Top menu button (TOP MENU) ☞ pg. 34
- 7 • Cursor buttons (▶/◀/▼/▲) ☞ pg. 34
 - Enter button (ENTER) ☞ pg. 17
- 8 • One Touch Replay button (↶) ☞ pg. 25
 - Record button (REC) ☞ pg. 18
- 9 Audio button (AUDIO) ☞ pg. 39, 40
- 10 Subtitle button (SUBTITLE) ☞ pg. 39
- 11 • VFP setting button ☞ pg. 42
 - Progressive mode button (PROGRESSIVE) ☞ pg. 22
- 12 Choice menu button (CHOICE) ☞ pg. 46
- 13 Setting button (SETTING) ☞ pg. 54
- 14 Title/group button (TITLE/GROUP) ☞ pg. 35
- 15 Repeat button (REPEAT) ☞ pg. 44
- 16 A-B repeat button (A-B REPEAT) ☞ pg. 45
- 17 Sleep button (SLEEP) ☞ pg. 21
- 18 Dimmer button (DIMMER) ☞ pg. 20
- 19 Surround buttons (SURROUND)
 - Mode (MODE), On/Off (ON/OFF) ☞ pg. 31
- 20 • Test tone button (TEST) ☞ pg. 32
 - Vocal replace button (VOCAL) (TH-M65 only) ☞ pg. 59, 60
- 21 • Effect button (EFFECT) ☞ pg. 32
 - Vocal effect button (EFFECT) (TH-M65 only) ☞ pg. 61
- 22 Subwoofer adjustment buttons (S.WFR +/-) ☞ pg. 21
- 23 Center speaker adjustment buttons (CENTER +/-) ☞ pg. 32
- 24 Standby-on button (⏻/⏿ AUDIO) ☞ pg. 19
- 25 Standby-on button (⏻/⏿ VCR/DBS) ☞ pg. 17
- 26 Standby-on button (⏻/⏿ TV) ☞ pg. 17
- 27 Source selecting buttons ☞ pg. 20
DVD, FM/AM, DBS, VCR
- 28 TV/Video mode button (TV/VIDEO) ☞ pg. 17
- 29 • Channel buttons (CHANNEL +/-) ☞ pg. 17
 - Key control buttons (KEY +/-) (TH-M65 only) ☞ pg. 61
- 30 Karaoke mode switch (KARAOKE ON/OFF) (TH-M65 only) ☞ pg. 56
- 31 Volume buttons (AUDIO VOL +/-) ☞ pg. 20
- 32 Menu button (MENU) ☞ pg. 34
- 33 On-screen button (ON SCREEN) ☞ pg. 33
- 34 • Number buttons ☞ pg. 17, 26, 35
 - TV returning button (TV RETURN) ☞ pg. 17
- 35 Return button (RETURN) ☞ pg. 4, 35
- 36 Angle button (ANGLE) ☞ pg. 38
- 37 Decode mode button (DECODE) ☞ pg. 22
- 38 Zoom button (ZOOM) ☞ pg. 41
- 39 Cancel button (CANCEL) ☞ pg. 43
- 40 Display window button (FL DISPLAY) ☞ pg. 24
- 41 • Treble adjustment buttons (TREBLE +/-) ☞ pg. 21
 - Reserve button (RESERVE) (TH-M65 only) ☞ pg. 57
 - Karaoke sound button (SOUND) (TH-M65 only) ☞ pg. 58
- 42 • Bass adjustment buttons (BASS +/-) ☞ pg. 21
 - Karaoke on/off button (KARAOKE) (TH-M65 only) ☞ pg. 56
 - Echo button (ECHO) (TH-M65 only) ☞ pg. 60
- 43 Surround speaker adjustment buttons (SURR) ☞ pg. 32
Left (L +/-), Right (R +/-)

Getting started

Connections

- Do not connect the AC power cord until all other connections have been made.
- Since different components often have different terminal names, carefully read the instructions supplied with the components you are going to connect.

Connecting a TV

To view pictures and on-screen displays, connect the TV to the center unit.

- You can get better picture quality in the order — Component video > S-video > Composite video.
- Distortion of picture may occur when connecting to the TV via a VCR, or to a TV with a built-in VCR.
- You need to set “MONITOR TYPE” in the PICTURE menu correctly according to the aspect ratio of your TV. (☞ pg. 49)

■ To connect a TV through the component video input jacks

If your TV has component video input jacks, connect them using a component video cord (not supplied) to view a high quality picture.

- Connect “Y” to “Y”, “PB” to “PB”, “PR” to “PR” correctly.
- If your TV supports progressive video input, you can enjoy a high quality picture by setting the progressive scan mode to active. (☞ pg. 22)

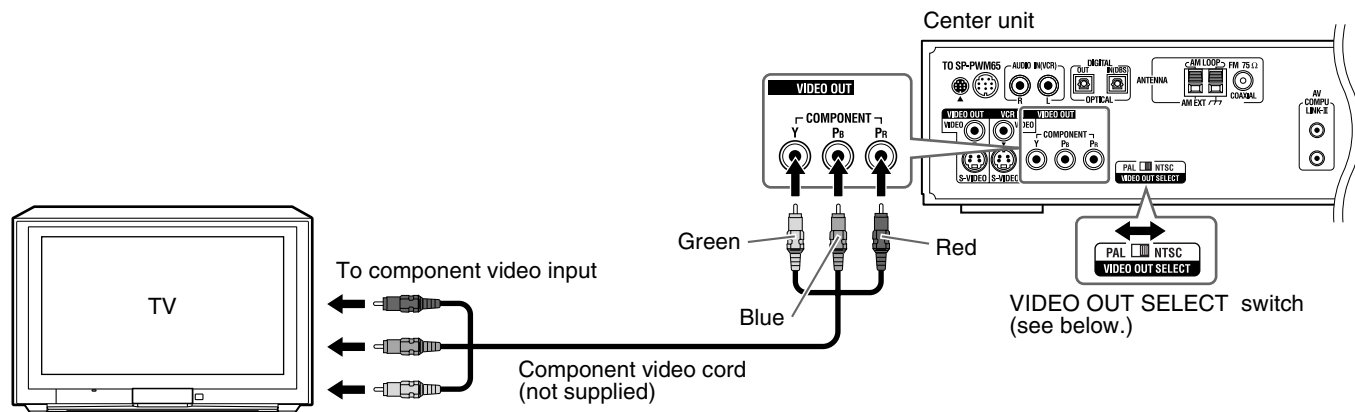

NOTE

- If the component video input jacks of your TV are of the BNC type, use a plug adapter (not supplied) to convert the pin plugs to BNC plugs.
- The component video signals can be output only when you select “DVD” as the source to play. (☞ pg. 20)

■ To connect a TV through the composite or S-video jacks

Connect the TV using the composite video cord (supplied) or an S-video cord (not supplied).

If your TV has an S-video (Y/C-separation) jack, you can get better picture quality than by using composite video connection.

- Connect the S-video cord by matching the ▼ mark on the plug to the one on the rear of the center unit.

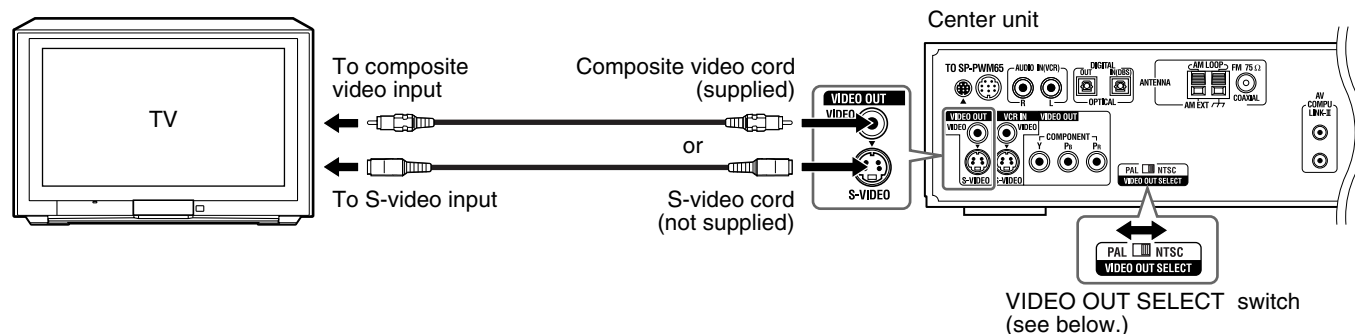

■ Selecting the color system

The center unit is compatible with the PAL and NTSC systems. Set the VIDEO OUT SELECT switch on the rear panel in standby mode to match the color system of your TV. Make sure that the color system of a DVD, Video CD, or SVCD disc labeled on the package matches your TV.

- If you use a multi-system TV, by setting “MONITOR TYPE” in the PICTURE menu to an appropriate “MULTI” option, the system outputs a video signal by the same format recorded on the disc (i.e. if you play an NTSC disc, the system outputs a signal by the NTSC format) regardless of the VIDEO OUT SELECT switch setting. (☞ pg. 49)

Getting started

Connecting the FM and AM antennas

Make sure the antenna conductors do not touch any other terminals, connecting cords and power cords. This could cause poor reception.

■ AM loop antenna

Setting up supplied AM loop antenna

Attach the AM loop to its base by snapping the tabs on the loop into the slot on the base.

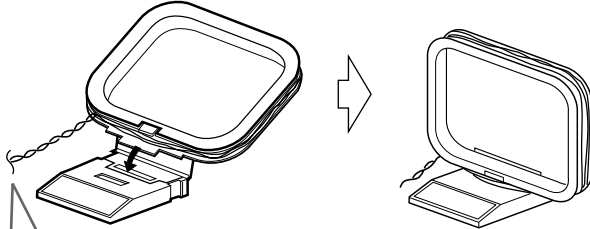

If the antenna cord is covered with the insulation coat, twist and pull the insulation coat off and remove.

Connecting AM loop antenna

Center unit

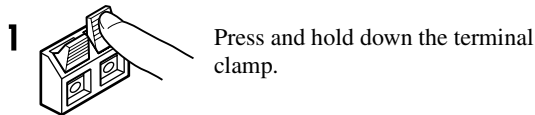
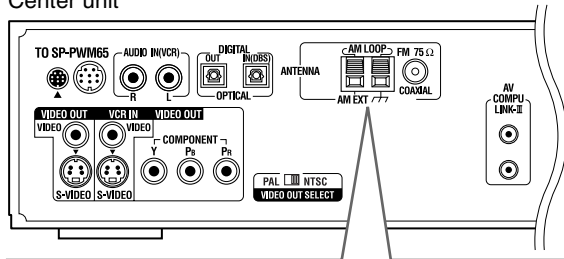

1 Press and hold down the terminal clamp.

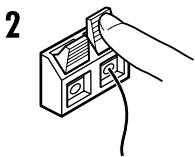

2 Insert the antenna cord.

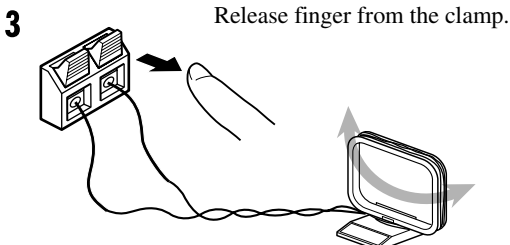

3 Release finger from the clamp.

- Turn the loop antenna until you have the best reception.

If reception is poor

Connect an outdoor single vinyl-covered wire antenna (not supplied) to the AM EXT terminal. (Keep the AM loop antenna connected.)

- Twist together both wires.

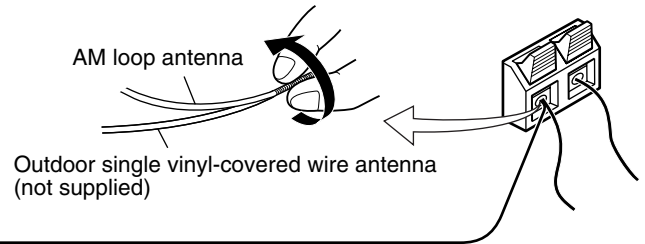

■ FM antenna

Connecting supplied FM antenna

Center unit

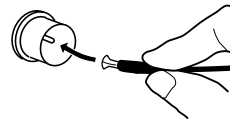
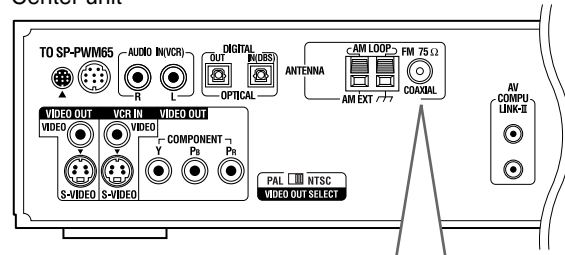

Extend the supplied FM antenna horizontally.

If reception is poor

Connect an outdoor FM antenna with standard type (75 Ω coaxial) connector.

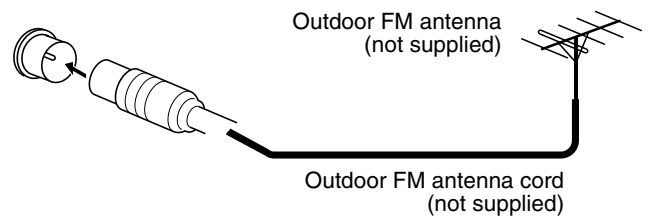

NOTE

- Disconnect the supplied FM antenna before attaching a 75 Ω coaxial connector (the kind with a round wire going to an outdoor antenna).
- We recommend that you use coaxial cable for the FM antenna as it is well-shielded against interference.

Connecting the powered subwoofer

Connect the supplied powered subwoofer (SP-PWM65/SP-PWM45) using the system cord (supplied).

- Connect the system cord by matching the ▲ marks on the plugs to the ones on the center unit and powered subwoofer.

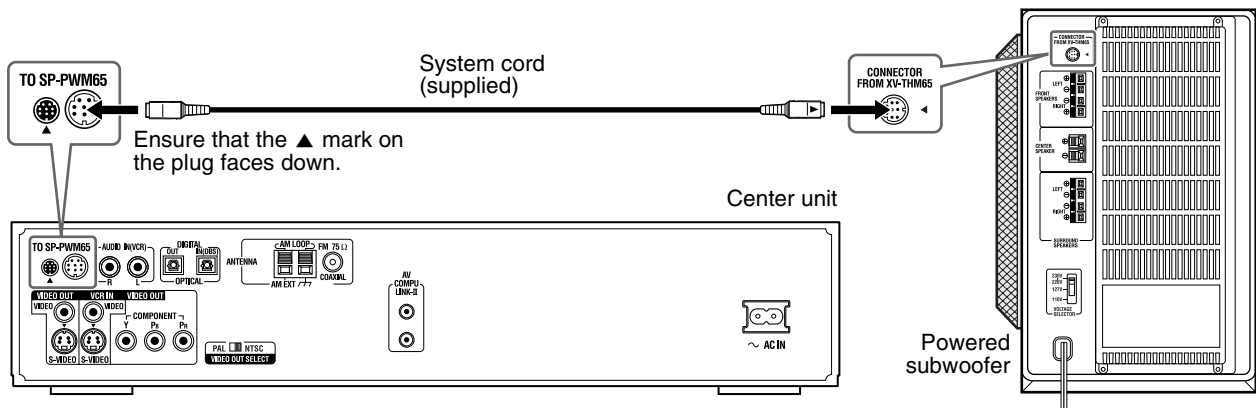

Connecting the satellite speakers

■ Speaker layout

When positioning the speakers, to obtain the best possible sound from this system you need to place all satellite speakers at the same distance from the listening position with the front of each speaker facing toward the listener.

When you cannot place them at the same distance from the listening position, you can make adjustment so that speakers operate as if they are placed at the best position. (pg. 50)

- Normally place the powered subwoofer in front of you. (Since bass sound is non-directional, you do not need to place it at the same distance as the other speakers.)

NOTE

- Although the satellite speakers and the powered subwoofer are magnetically shielded, the TV screen may appear mottled. In this case, keep the distance between them to the TV to over 10 cm.
- For safety reasons, always ensure that there is sufficient space behind the powered subwoofer.
- When you position the satellite speakers in a relatively high place, such as the top of your bookshelf, place them on a flat and level surface.
- Speaker grilles are not removable. Trying to remove them by force may damage them.

TH-M45

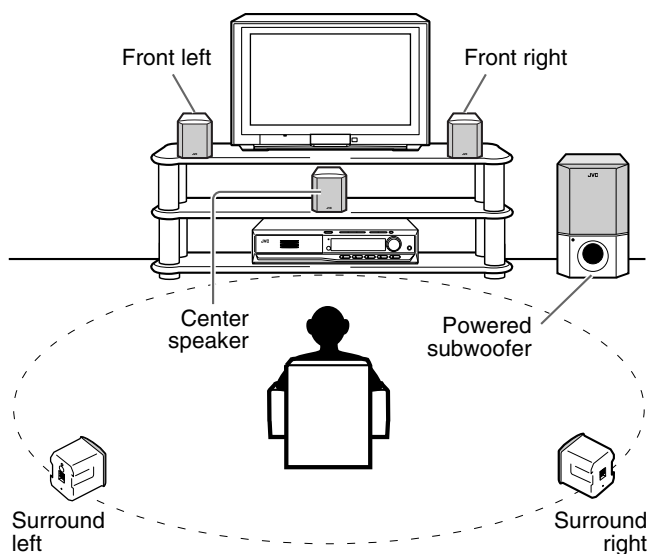

TH-M65

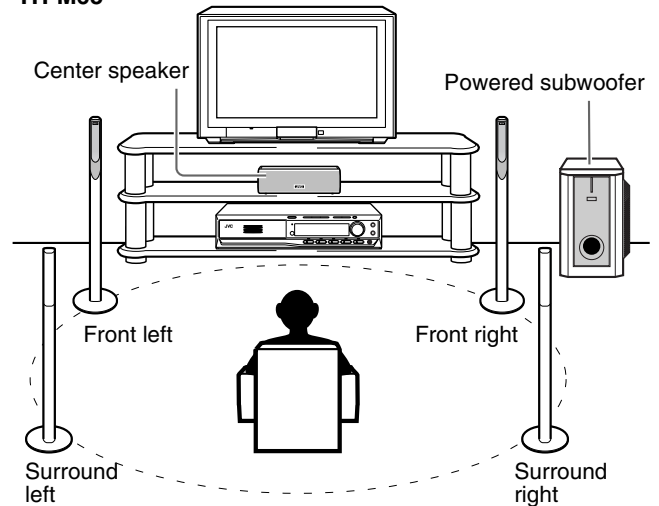

NOTE

For TH-M65 only:

- Be sure to place the powered subwoofer to the TV's right. If you place the powered subwoofer to the TV's left, keep sufficient distance between them to prevent the TV screen from appearing mottled.
- Do not lean against the satellite speakers, as the speakers could fall down or break, possibly causing injury. Especially be careful not to let children lean against them.

■ Assembling the satellite speakers (TH-M65 only)

Each speaker (except the center speaker) has been divided into two parts for shipment. Before connecting the satellite speakers, first assemble them by following the procedure below.

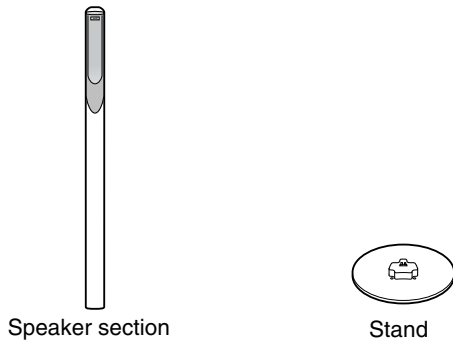

Before assembling —

- Prepare a Phillips screwdriver.
- Take care not to drop the stand while assembling; otherwise, it may cause damage to the floor or injury.
- Ensure enough space exists for assembly and installation.
- Spread a large, thick cloth on the floor where you assemble the speakers, so you can protect the floor and the speaker itself.

1 Connect the speaker connectors to the stand connectors.

- Be sure to connect the speaker connectors by matching their sizes.

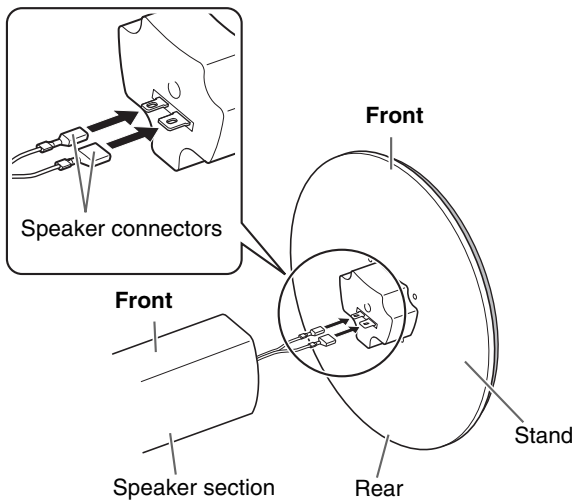

2 Join the stand to the speaker section.

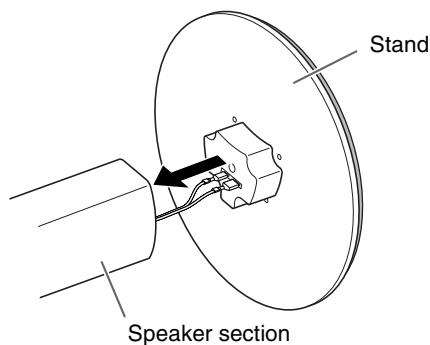

3 Fix the stand to the speaker section.

- Be sure to tighten the screws firmly.

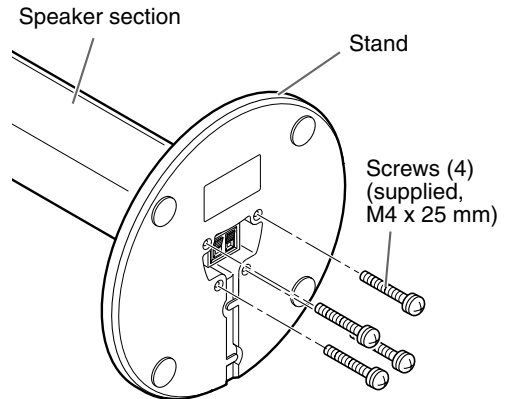

Repeat the procedure from step 1 to assemble the other satellite speakers.

NOTE

- Use the speaker after assembly is fully and correctly done.
- It is recommended to place a cushion under the speaker section. You can tighten the screws easily by placing the speaker section horizontally.

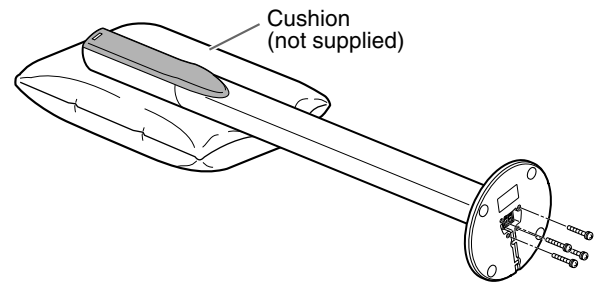

■ Connecting the satellite (front, center, surround) speakers (TH-M65)

Each speaker (SP-THM65F) can be used as a front or surround speaker.

CAUTION

- When you connect (larger) speakers other than the supplied ones, only use speakers with the same speaker impedance (SPEAKER IMPEDANCE) as indicated by the speaker terminals on the rear of the powered subwoofer.
- DO NOT connect more than one speaker to one speaker terminal.

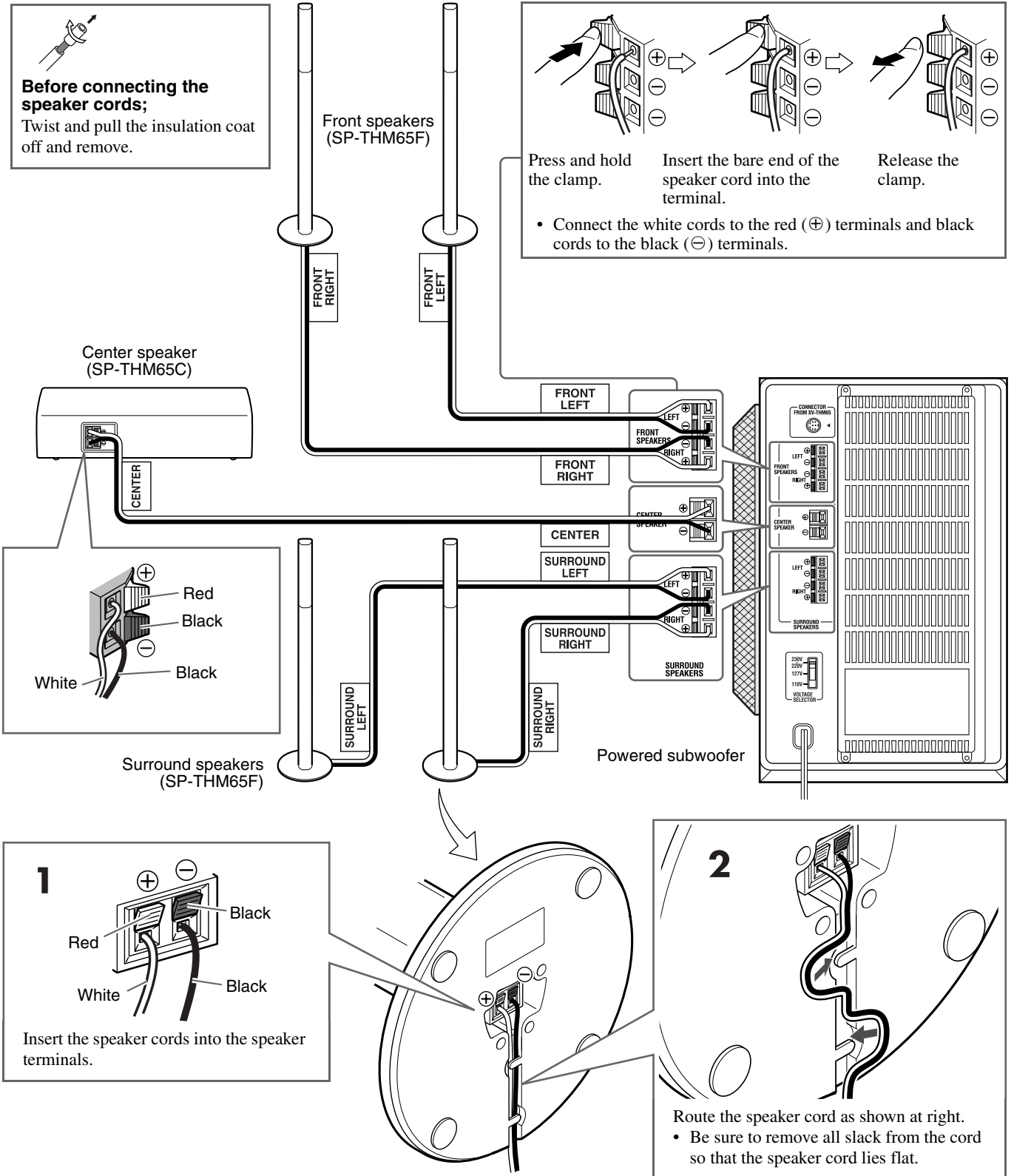

■ **Connecting the satellite (front, center, surround) speakers (TH-M45)**

Be sure to identify each speaker (SP-THM45C/SP-THM45F/SP-THM45S) and connect them to the corresponding terminals of the powered subwoofer.

CAUTION

- When you connect (larger) speakers other than the supplied ones, only use speakers with the same speaker impedance (SPEAKER IMPEDANCE) as indicated by the speaker terminals on the rear of the powered subwoofer.
- DO NOT connect more than one speaker to one speaker terminal.

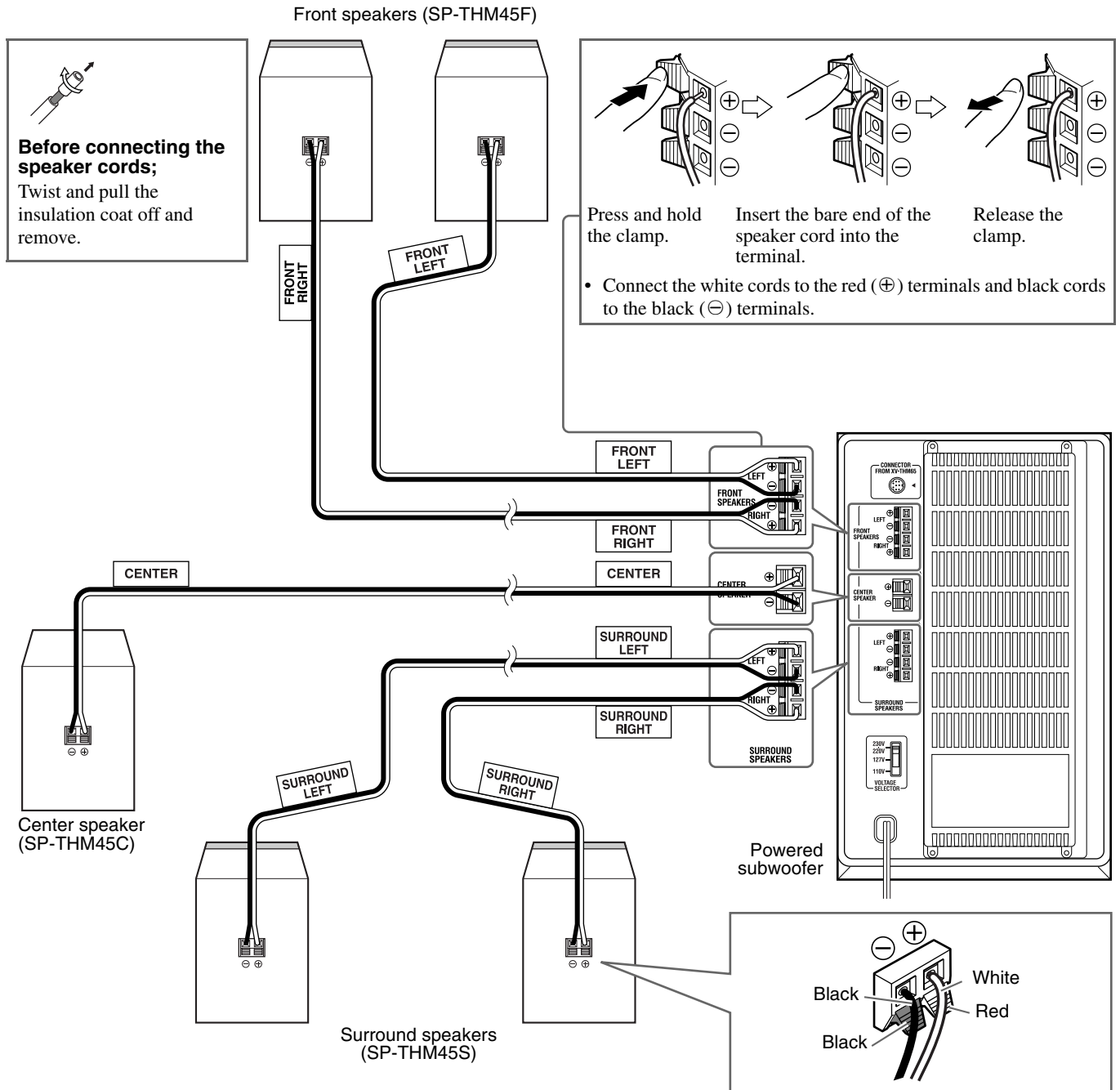

CAUTION

- When installing the satellite speakers on the wall;
- Be sure to have them installed on the wall by a qualified personnel.
DO NOT install the satellite speakers on the wall by yourself to avoid unexpected damage from their falling off the wall due to incorrect installation or weakness in wall structure.
 - Care must be taken in selecting a location for speaker installation on a wall. Injury to personnel or damage to equipment may result if the speakers installed interfere with daily activities.

Connecting to an analog component

You can enjoy the sound of an analog component such as a VCR, TV, or Cassette recorder with this system. Use RCA pin plug cords (not supplied) for connection.

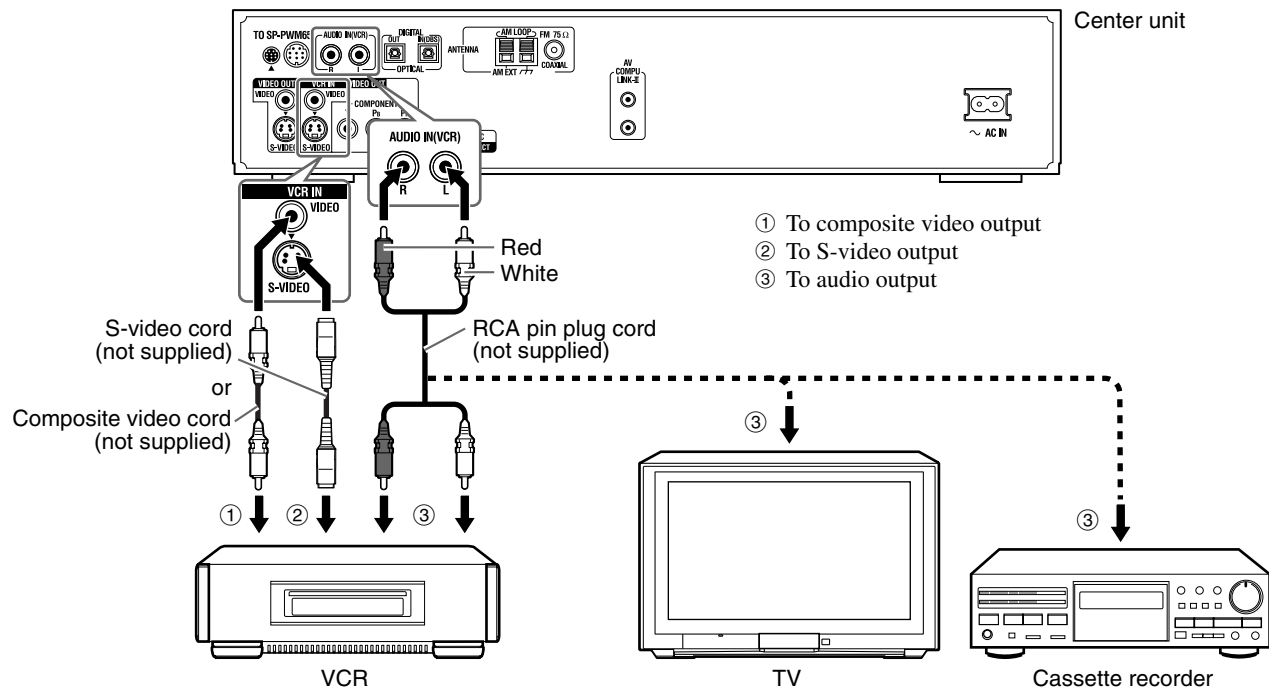

NOTE

- The signals input to the VIDEO jack of the VCR IN jacks will be output only from the VIDEO jack of the VIDEO OUT jacks, not from the S-VIDEO jack of the VIDEO OUT jacks.

Connecting to a digital component

You can enjoy the sound of a digital component such as a DBS (Direct Broadcast Satellite) tuner or MD recorder with this system. Use digital optical cord (not supplied) for connection.

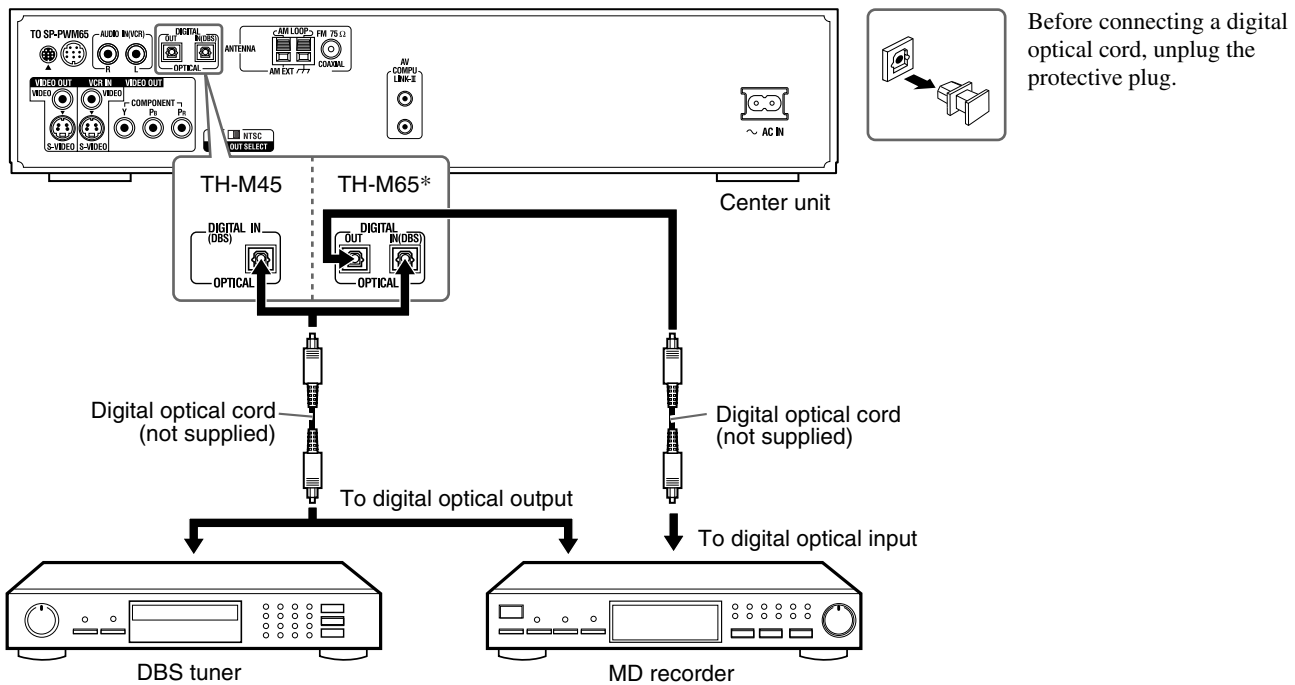

- * For TH-M65 only:
This system can send digital audio signals to digital component such as MD recorder or AV receiver.

NOTE

- Only digital audio signals can be input when selecting "DBS" as the source to play. (pg. 20) When connecting a video component such as a DBS tuner, operate this system to listen to the sound.

Getting started

Setting the VOLTAGE SELECTOR switch

To avoid damaging the powered subwoofer, set the VOLTAGE SELECTOR switch on the rear panel to the correct voltage for your area. When you change the position of the VOLTAGE SELECTOR switch, use a tool such as a slotted screwdriver, etc.

CAUTION

DO NOT plug the power cord of the powered subwoofer before setting the VOLTAGE SELECTOR switch to the correct voltage.

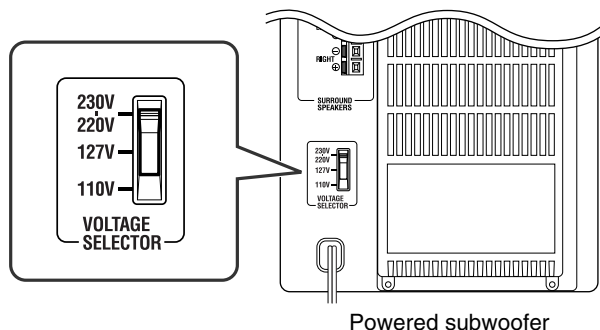

Connecting the power cord

Make sure that all connections have been completed, before plugging in the power cords of the center unit and powered subwoofer.

- 1** Firmly insert the supplied power cord into the \sim AC IN socket on the rear of the center unit.
- 2** Plug both power cords into AC outlets.

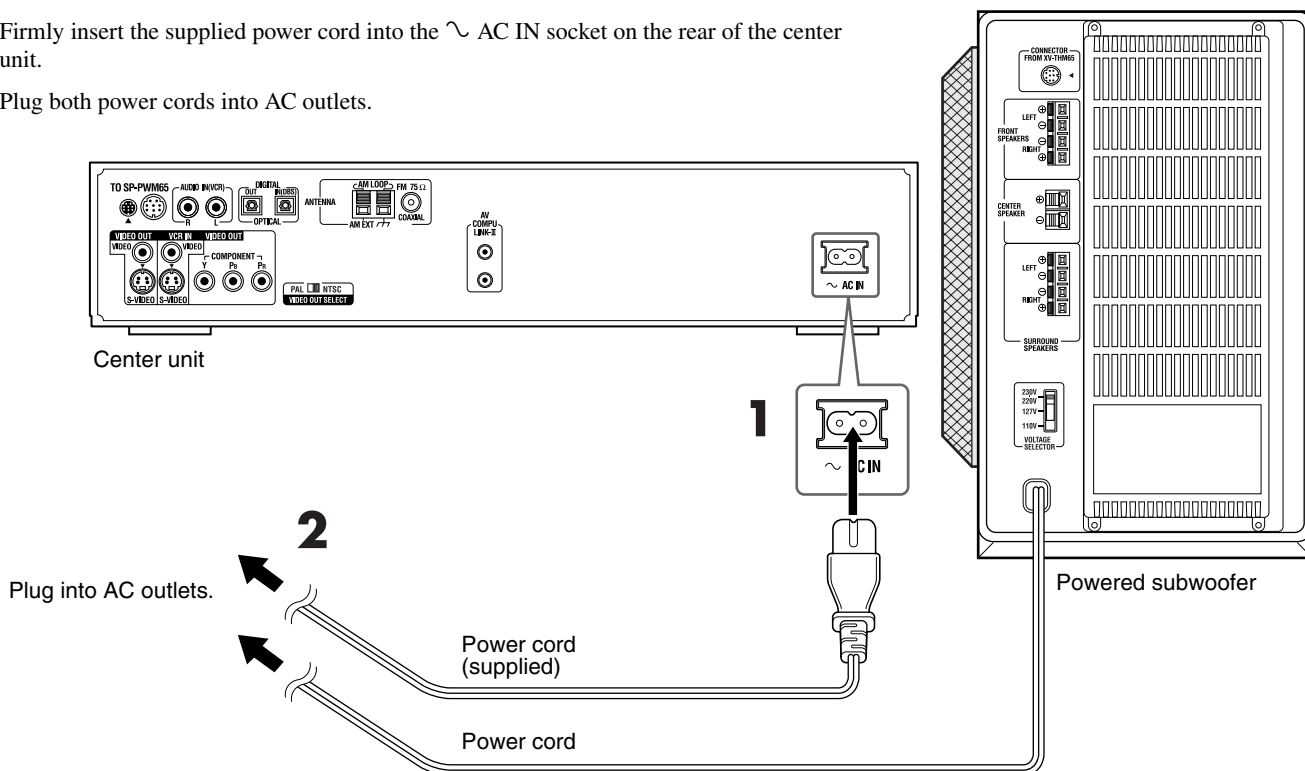

CAUTION

- Disconnect the power cord before cleaning or moving the system.
- Do not touch the power cord with wet hands.
- Do not pull on the power cord to unplug the cord. When unplugging the cord, always grasp and pull the plug so as not to damage the cord.

NOTE

- Keep power cords away from other connected cords. The power cords may cause noise or screen interference.
- Preset settings, such as preset stations and surround mode adjustment, may be erased in a few days in the following cases;
 - If you unplug the power cord of the center unit.
 - If a power failure occurs.
- The speakers will not produce any sound if the power cord of the powered subwoofer is removed from the AC outlet while the center unit is turned on. In this case, press \odot /I AUDIO on the remote control or \odot /I STANDBY/ON on the center unit to turn the power off, plug in the powered subwoofer, then press \odot /I AUDIO or \odot /I STANDBY/ON again.
- If the AC outlets do not match the AC plugs, use the supplied AC plug adaptors.

Using the remote control

The remote control makes it easy to use many of the system functions from a distance of up to 7 m away.

- You can also use the remote control supplied for this system to operate other manufacturers' TVs (☞ pg. 17), VCRs (☞ pg. 18) and DBS tuners/CATV converters (☞ pg. 17).

Putting batteries in the remote control

Before using the remote control, first put in the 2 supplied batteries.

- 1 Remove the battery cover on the back of the remote control.**

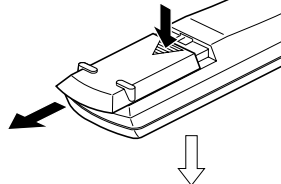

- 2 Insert the batteries.**

- Make sure to match polarity: (+) to (+) and (-) to (-).

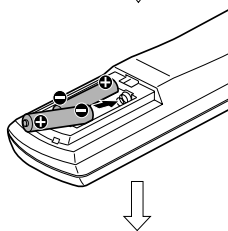

- 3 Replace the cover.**

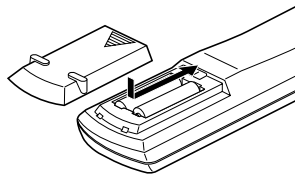

If the range or effectiveness of the remote control decreases, replace the batteries. Use two R6P (SUM-3)/AA (15F) type dry-cell batteries.

CAUTION

- Follow these precautions to avoid leaking or cracking batteries;
 - Use the correct type of batteries. Batteries that look similar may differ in voltage.
 - Always replace both batteries at the same time.
 - Do not expose batteries to heat or flame.

Operating the system from the remote control

Aim the remote control directly at the remote sensor on the center unit.

- To control other components, aim the remote control directly at the remote sensor on each component. Refer also to their instruction manuals.
- To operate the remote control properly, do not hide the remote sensor by placing any obstructions in front of it.

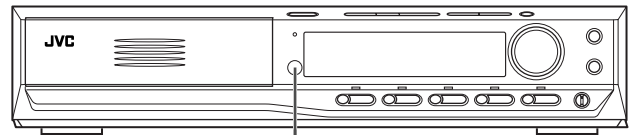

Remote sensor

Getting started

4 Press number buttons (1-9, 0) to enter the manufacturer's code (2 digits).

Examples:

For a GI Jerrold product: Press 0, then 1.

For a Sony product: Press 2, then 0.

Manufacturer	Code
Echostar	21
GI Jerrold	01, 02, 03, 04, 05, 06, 07, 08
Hamin/Regal	15, 16, 17, 18
Pioneer	13, 14
RCA	19
Scientific Atlanta	09, 10
Sony	20
Zenith	11, 12

5 Release DBS.

6 Try operating your DBS tuner or CATV converter by pressing VCR/DBS.

When your DBS tuner or CATV converter turns on or off, you have entered the correct code.

If there is more than one code listed for your brand, try each one until you enter the correct one.

NOTE

- Manufacturers' codes are subject to change without notice. If they are changed, this remote control cannot operate the equipment.
- Set the codes again after replacing the batteries of the remote control.

■ Operation

IMPORTANT

Before using the remote control to operate a DBS tuner or CATV converter;

- Set the remote control mode selector to VCR/DBS.
- Press DBS.

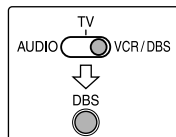

The following buttons are available:

 VCR/DBS: Turns DBS tuner or CATV converter on and off.

CHANNEL +/-*: Changes the channels.

1-10, 0, +10 (100+): Selects the channel.

* Be sure to set the Karaoke mode switch to OFF before using CHANNEL +/- (for TH-M65 only)

For VCR operations

You can operate your VCR using the remote control supplied with this system.

- Refer also to the instruction manuals supplied with your VCR.

■ To set the manufacturer's code

1 Slide the remote control mode selector to VCR/DBS.

2 Press and hold VCR.

Keep the button pressed until step 4 is finished.

3 Press ENTER.

4 Press number buttons (1-9, 0) to enter the manufacturer's code (2 digits).

Examples:

For a Philips VCR: Press 0, then 9.

For an NEC VCR: Press 2, then 5.

Manufacturer	Code	Manufacturer	Code
JVC	01, 02, 03	Philips	09
Emerson	11, 26	RCA	05, 06
Fisher	29	Samsung	24
Funai	10, 14, 15, 16	Sanyo	21, 22, 23
Gold Star	12	Sharp	27, 28
Hitachi	04	Shintom	30
Mitsubishi	13	Sony	18, 19, 20
NEC	25	Zenith	08
Panasonic	07, 17		

5 Release VCR.

6 Try operating your VCR by pressing VCR/DBS.

When your VCR turns on or off, you have entered the correct code.

If there is more than one code listed for your brand, try each one until you enter the correct one.

NOTE

- Manufacturers' codes are subject to change without notice. If they are changed, this remote control cannot operate the equipment.
- Set the codes again after replacing the batteries of the remote control.

■ Operation

IMPORTANT

Before using the remote control to operate a VCR;

- Set the remote control mode selector to VCR/DBS.
- Press VCR.

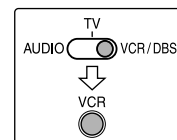



The following buttons are available:

 VCR/DBS: Turns VCR on and off.



 (play button): Starts playback.

 : Stops operation.

 : Pauses playback.

 : Fast forwards video tape.

 : Rewinds video tape.

REC: Press this button together with  (play button) to start recording or together with  to pause recording.

CHANNEL +/-*: Changes the TV channels on the VCR.

1-10, 0: Selects the channel. (for the JVC's VCR only)

* Be sure to set the Karaoke mode switch to OFF before using CHANNEL +/- (for TH-M65 only)

NOTE

When operating a VCR or DBS tuner/CATV converter;

- The source setting of VCR or DBS remains after you have changed the remote control mode selector to AUDIO or TV. When operating VCR or DBS tuner/CATV converter again, it is not necessary to press VCR or DBS after setting the remote control mode selector.

Basic operations

This section mainly explains operations commonly used when you enjoy this system.

- Turn on your TV and select the correct input mode on the TV.

IMPORTANT

Before using the remote control for the following operation,

- Set the remote control mode selector to AUDIO.

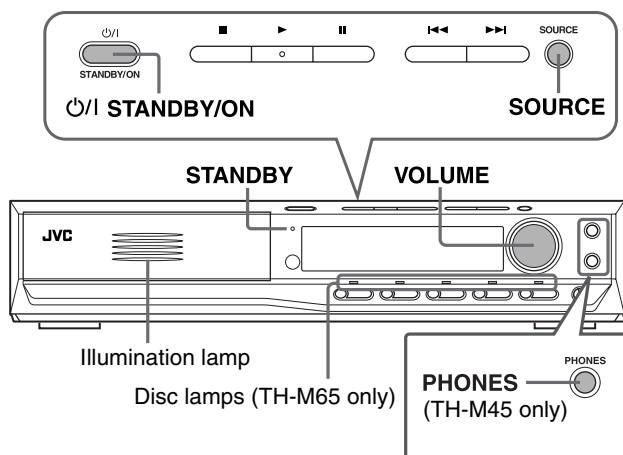
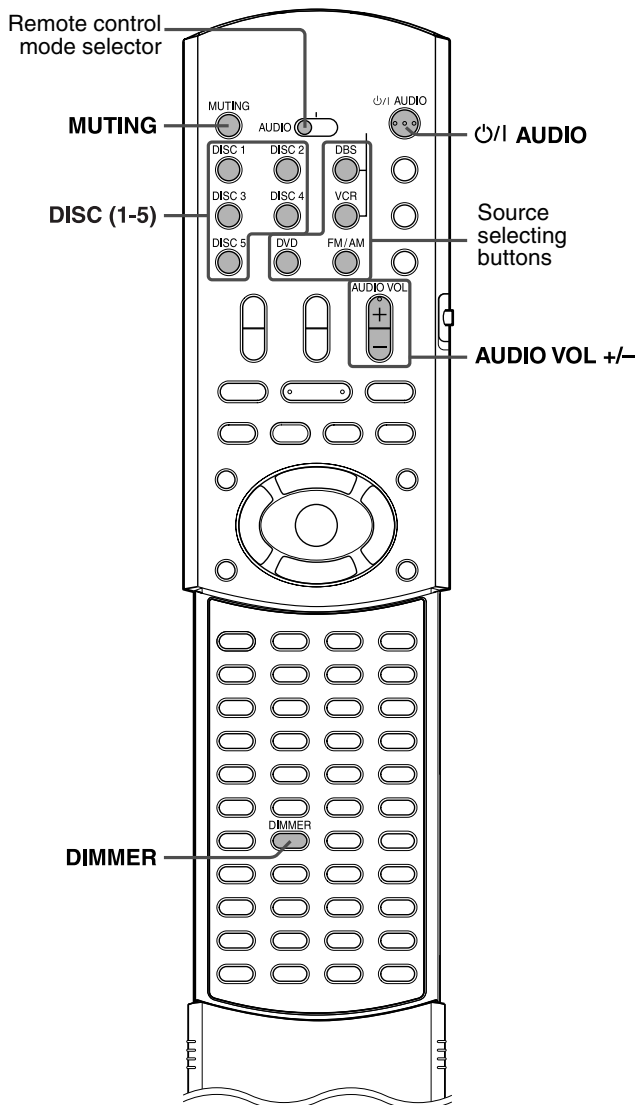
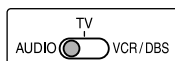

Turning the system on/off

- To turn the power on
On the remote control:
Press **⏻/I AUDIO**.

- On the center unit:
Press **⏻/I STANDBY/ON**.

The STANDBY lamp goes off.

When DVD is selected as the source (see pg. 20), the opening screen* appears on the TV screen.

* Opening screen

The following messages may appear in the message area depending on the status of this system.

- “OPEN”/“CLOSE”:
Appears when opening or closing the selected disc tray.
- “NOW READING”:
Appears when the system is reading the disc information.
- “REGION CODE ERROR!”:
Appears when the Region Code of the DVD does not match the code the center unit supports. The DVD cannot be played back.
- “NO DISC”:
Appears when no disc is loaded to the selected disc tray.

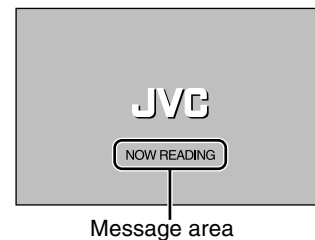

- To turn the power off
On the remote control:
Press **⏻/I AUDIO** again.

- On the center unit:
Press **⏻/I STANDBY/ON** again.

The STANDBY lamp lights.

NOTE

- The power supply to the subwoofer is linked to the center unit. The POWER ON lamp on the subwoofer lights green when the power is turned on.
- A small amount of the power is consumed even when the power is turned off (center unit only). This is called standby mode and the STANDBY lamp lights in this mode. Unplug the power cord from the AC outlet to turn the power off completely.
- You can also turn on the system by pressing the following buttons;
 - One of **▲** buttons on the center unit
 - One of the source selecting buttons on the remote control
 - One of the DISC (1-5) buttons or **▶** on the center unit.
 You can use the same buttons on the remote control except after pressing FM/AM.

Selecting the source to play

On the remote control:

Press one of the source selecting buttons (DVD, FM/AM, VCR or DBS).

DVD: To play back a disc (DVD, Video CD etc.). (☞ pg. 23, 25)

FM/AM: To tune in an FM or AM station. (☞ pg. 27)

Each time you press the button, the band alternates between FM and AM.

VCR: To select the source from a component connected to the VCR IN jacks and AUDIO IN (VCR) jacks. (☞ pg. 14)

DBS: To select the source from a component connected to the DIGITAL IN (DBS) jack. (☞ pg. 14)

On the center unit:

Press SOURCE repeatedly until the source name you want appears on the display window.

Each time you press the button, the source changes as follows;

⇒ DVD ⇒ AM ⇒ FM ⇒ VCR ⇒ DBS ⇒ (back to the beginning)

The selected source name appears on the display window.

Example: When "VCR" is selected.



NOTE

- When AM, FM or DBS is selected as the source, this system does not output video signals.

Adjusting the volume

CAUTION

- Always set the volume to minimum level before starting any source. If the volume is set at its high level, the sudden blast of sound could permanently damage your hearing and/or blow out the speakers.

You can adjust the volume level within the range from "0" (minimum) to "60" (maximum).

On the remote control:

Press AUDIO VOL + or –.

- Press + to increase volume.
- Press – to decrease volume.

On the center unit:

Turn VOLUME.

- Turn VOLUME clockwise to increase volume.
- Turn VOLUME counterclockwise to decrease volume.

The volume level appears on the display window.

Listening with headphones (TH-M45 only)

CAUTION

Be sure to turn down the volume;

- Before connecting or putting on headphones as high volume may damage both the headphones and your hearing.
- Before disconnecting headphones as high volume may be suddenly output from the speakers.

Connect a pair of headphones to the PHONES jack on the center unit. This cancels the surround mode (☞ pg. 31) currently selected, deactivates the speakers, turns the subwoofer's power off, and activates the headphone mode. "HEADPHONE" appears on the display window.



- Disconnecting a pair of headphones from the PHONES jack cancels the headphone mode and activates the speakers at the previously selected surround mode.

Headphone mode

When using the headphones, the following signals are output regardless of your speaker setting;

- For 2 channel sources, the front left and right channel signals are output directly from the left and right headphones.
- For multi-channel sources, the front left and right, center and surround channel signals are down-mixed and then output from the headphones. You can enjoy the down-mixed multi-channel sound source using the headphones.

Turning off the sound temporarily

On the remote control:

Press MUTING.

"MUTING" appears on the display window and the sound turns off.



To restore the sound

Press MUTING again.

- Pressing AUDIO VOL +/- (or turning VOLUME on the center unit) also restores the sound.

Adjusting the brightness

You can dim the indications on the display window, the illumination lamp level and the disc lamps (TH-M65 only) on the center unit.

On the remote control:

Press DIMMER.

Each time you press the button, the brightness level changes as follows;

⇒ OFF ⇒ DIMMER1 ⇒ DIMMER2 ⇒ (back to the beginning)

- OFF: Returns to the normal level.
- DIMMER1: Dims the display window, the illumination lamp and the disc lamps (TH-M65 only).
- DIMMER2: Dims the display window more than DIMMER1 and turns off the illumination lamp.

Basic operations

IMPORTANT

Before using the remote control for the following operation,

- Set the remote control mode selector to **AUDIO**.

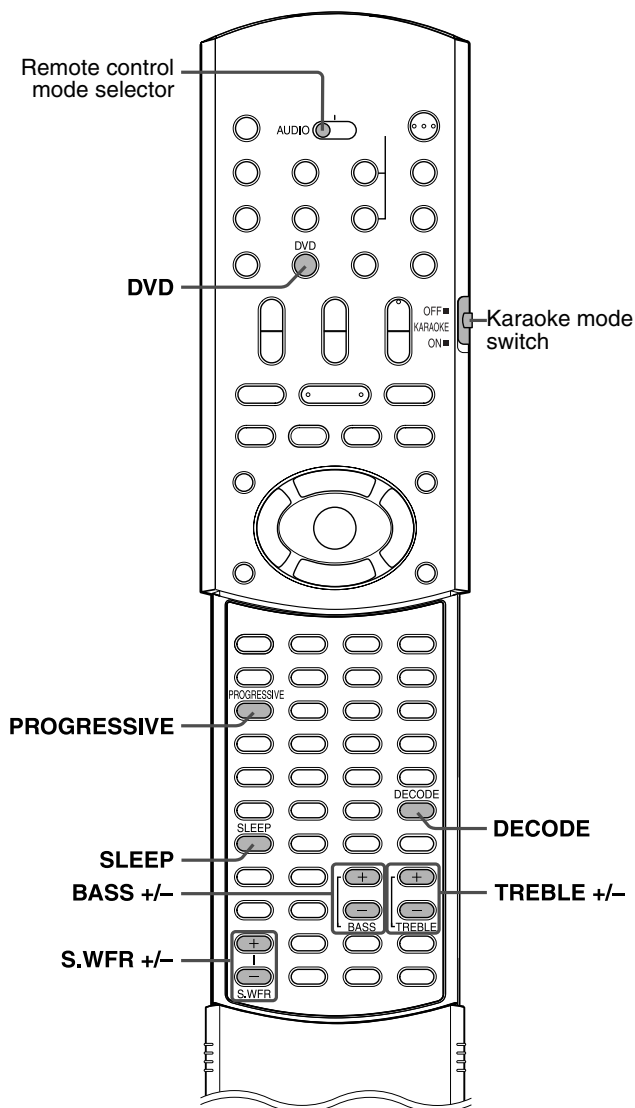
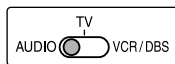

Using the Sleep Timer

Using the Sleep Timer, you can fall asleep while listening to music and know the system will turn off by itself rather than play all night.

On the remote control:

Press SLEEP.

Each time you press the button, the shut-off time changes as follows;

⇒ **0min (cancelled)** ⇒ **10min (minutes)** ⇒ **20min** ⇒ **30min**
 ⇒ **60min** ⇒ **90min** ⇒ **120min** ⇒ **150min** ⇒ **(back to the beginning)**

To check the remaining time until the shut-off time

Press **SLEEP** once.

- The remaining time until the shut-off time appears on the display window for a while.

To change the remaining time until the shut-off time
 Press **SLEEP** repeatedly.

- Each time you press the button, the shut-off time changes.

To cancel the Sleep Timer

Press **SLEEP** repeatedly until “0min” appears on the display window.

- Turning off the power also cancels the Sleep Timer.

NOTE

- When DVD is selected as the source to play, the system can also turn off automatically if playback is not restarted within the length of time you have specified (Auto Standby function). (☞ pg. 51)
- When both the Sleep Timer and Auto Standby function are activated, if the shut-off time set by the Auto Standby function comes earlier than the one set by the Sleep Timer, the Auto Standby function controls shut-off time.

Adjusting the output level of the subwoofer

You can adjust the output level within the range from -10 to +10.

On the remote control:

Press S.WFR +/-.

NOTE

- You can also make adjustments using the choice menu shown on the TV screen. (☞ pg. 50)
- The adjustments on a source take effect for the other sources.

Adjusting the bass/treble sound

You can adjust each enhancement level from the front speakers within the range from -10 to +10.

NOTE

Before you start operation;

- Set the Karaoke mode switch to OFF. (for TH-M65 only)

On the remote control:

Press BASS +/- for bass sound.

Press TREBLE +/- for treble sound.

NOTE

- You can also make adjustments using the choice menu shown on the TV screen. (☞ pg. 49)
- The adjustments on a source take effect for the other sources.
- You can adjust bass/treble enhancement level only for front left/right channel. However, the supplied speakers cannot add the effective change to the bass sound because of their cutoff frequency even if the bass sound adjustment is made. (☞ pg. 50)
 To change the bass enhancement level more efficiently, adjust the output level of the subwoofer. (☞ “Adjusting the output level of the subwoofer”)
 (When you change the front speakers to the larger ones and select “LARGE” for the front speakers in the SIZE sub-menu (☞ pg. 50), the effective adjustment of bass sound is also possible by pressing BASS +/-.)

Changing the decode mode

When you play a disc (or software) encoded with Dolby Digital or DTS Digital Surround, the following symptoms may occur:

- Sound does not come out at the beginning of playback.
- Noise comes out while searching for or skipping chapters or tracks.

In these cases, change the decode mode to “DOLBY D” (for Dolby Digital) or “DTS” (for DTS Digital Surround).

- When DVD or DBS is selected as the source

On the remote control:

Press DECODE to select the decode mode.

The current decode mode appears on the display window.

Example: When “AUTO/PCM” is selected.



Each time you press the button, the decode mode changes as follows;

⇒ **AUTO/PCM** ⇒ **DOLBY D** ⇒ **DTS** ⇒ **(back to the beginning)**

- **AUTO/PCM:** Normally select this. The system automatically detects the incoming signals.
- **DOLBY D:** Select this if the symptoms above occur when playing a disc (or software) encoded with Dolby Digital.
- **DTS:** Select this if the symptoms above occur when playing a disc (or software) encoded with DTS Digital Surround.

NOTE

- When “DOLBY D” or “DTS” is selected, if a signal encoded with another digital format comes in, you cannot listen to the sound. (The **DIGITAL** or **DTS** indicator flashes.)
- Changing the source returns the decode mode to “AUTO/PCM” automatically.

Changing the scan mode

This system supports the progressive scan system (525p*) as well as the conventional interlaced scan system (525i*).

If your TV equipped with component jacks supports the progressive video input, you can enjoy a high quality picture by setting the progressive scan mode to active.

- Refer also to the instruction manuals supplied with your TV.
- If your TV equipped with component jacks does not support the progressive video input, do not change the scan mode to the progressive scan mode.

* 525p and 525i indicate the number of scanning lines and scanning format of an image signal.

- 525p indicates 525 scanning lines with progressive format.
- 525i indicates 525 scanning lines with interlaced format.

- When DVD is selected as the source

On the remote control:

1 Press DVD.

2 Press and hold PROGRESSIVE for 3 seconds.

Each time you perform this operation, the scan mode changes as follows;

INTERLACE ⇄ PROGRESSIVE

- **INTERLACE:** Select this if your TV equipped with component jacks supports the interlaced video input only.
- **PROGRESSIVE:** Select this if your TV equipped with component jacks supports the progressive video input.

When “PROGRESSIVE” is selected, the PROGRESSIVE indicator lights.

NOTE

- When “PAL” is selected on the VIDEO OUT SELECT switch (pg. 8), the scan mode is fixed to “INTERLACE”. So the scan mode cannot be changed.
- There are some progressive TVs and High-Definition TVs that are not fully compatible with this system, resulting in an unnatural picture when playing back a DVD in the progressive scan mode. In such a case, change the scan mode to “INTERLACE”. To check the compatibility of your TV, contact your local JVC customer service center.
- All JVC progressive TVs and High-Definition TVs are fully compatible with this system.

Playback

This section explains basic operations of DVD player. For more details about DVD player operations, see pages 33 to 45.

- shows the types of discs the operation is available for.
- Turn on your TV and select the correct input mode on the TV.

IMPORTANT

Before using the remote control for the following operation;

- 1 Set the remote control mode selector to **AUDIO**.
- 2 Press **DVD**.

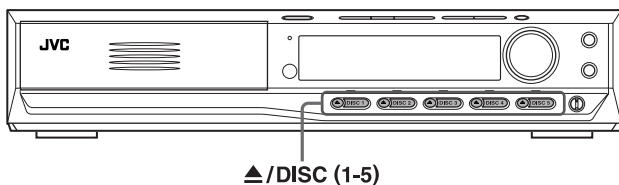
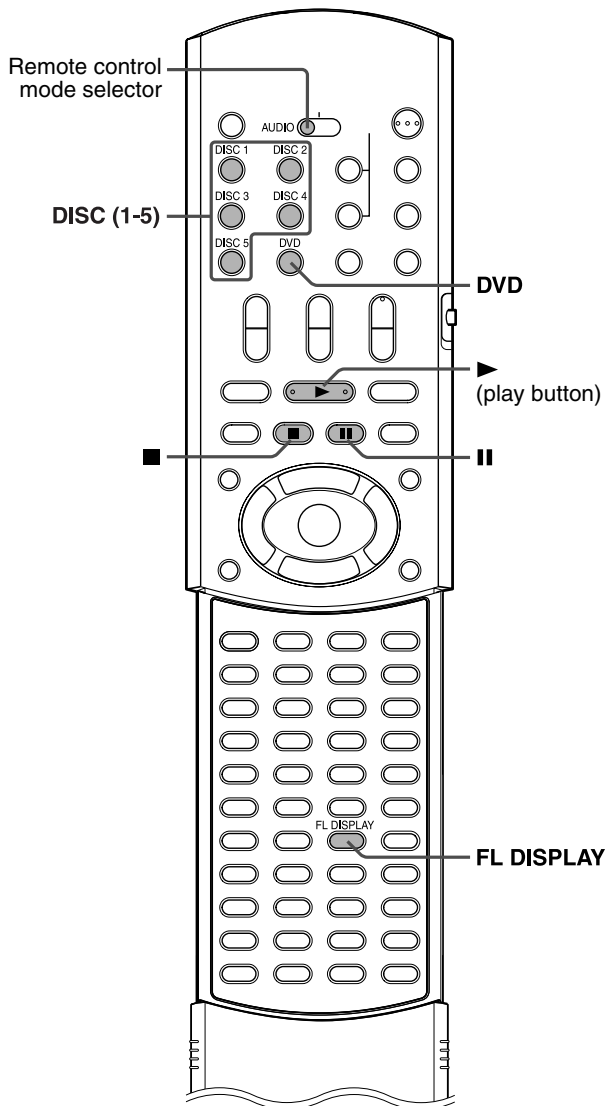
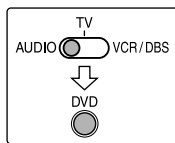

Basic playback

■ To load a disc

Up to 5 discs can be loaded.



1 Press ▲ for a desired disc tray on the center unit to open the disc tray.

The system turns on and the disc tray comes out.

2 Place a disc on the disc tray.

With the label side up

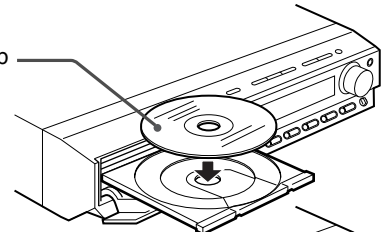

When placing an 8 cm disc

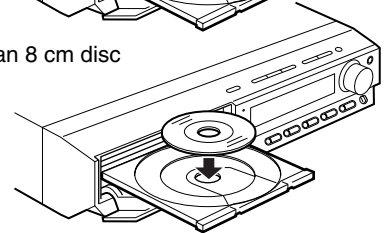

■ To start playback

3 Press the selected DISC (1-5) button.

The system starts playback after closing the disc tray.

You can use the same buttons on the center unit for operations unless otherwise noted.

When loading an MP3 disc

The MP3 control display (☞ pg. 36) appears on the TV screen and playback starts from the first track in the first group after pressing the DISC button in step 3. When all tracks in a group have been played, the system starts playback of tracks in the next group.

When loading a JPEG disc

The slide-show* playback starts from the first file in the first group after pressing the DISC button in step 3. When stopping playback of a JPEG disc, the JPEG control display (☞ pg. 37) appears on the TV screen.

* Slide-show

Each file (still picture) is shown on the TV screen for about 3 seconds, then changed to the next file one after another automatically. When all files in a group have been played, the system starts playback of files in the next group.

■ To pause playback

Press **II**.

To return to normal playback, press ► (play button).

■ To stop playback

Press **■**.

To change the playback disc while playing back the another disc

Press the desired DISC (1-5) button.

- If no disc is set in the specified tray, the system starts playback of the disc in the next tray automatically.

To remove a disc

Press ▲ for a desired disc tray on the center unit.

NOTE

- You can also start playback by pressing ► (play button) or DVD.
- Regardless of the operation for starting playback, the system plays back all available discs sequentially until you stop playback. However, the system stops playback after playback of the disc in the fifth tray.
- When Video CDs/SVCDs with PBC function (pg. 4) or DVD that automatically go to the menu screen and wait for the next instruction, the system does not move to the next disc. In such a case, select the item to be played back from the menu. (pg. 35)
- You can check playback information on the display window and the TV screen. (pg. 33)
- Some tracks on an MP3 disc may be skipped or may not be played back normally.
- When you play back a JPEG disc, press buttons after the whole picture appears on the TV screen. The system cannot accept operations even though you press buttons while showing a picture.
- Some files on a JPEG disc may be played back distortedly.
- If a black screen continuously appears in the slide-show playback, the file currently being played may be a non-baseline JPEG file. In this case, select a playable file (a baseline JPEG file). For example, press ■ or MENU to open the JPEG control display, etc. Note that it may take a long time to select another file.

■ Resume Playback (DVD/Video CD/SVCD only)

When Resume Playback is set to “ON” (pg. 51) and you stop playback by the following operations, the position where playback has been stopped is stored. (The RESUME indicator lights.)

- Turning off the power (pg. 19)
- Pressing ■
- Changing the source (pg. 20)

To start playback from the stored position

(The RESUME indicator goes off.)

- Press the selected DISC button or ► (play button) on the remote control or the center unit.
- Select DVD as the source again if you changed the source.

To clear the stored position

Press ■ again or open the disc tray with the playback disc.

- When the stored position has been cleared, playback starts from the beginning of the disc.

■ To prevent screen burn-out with the screen saver

A TV screen may burn out if a static picture is displayed for a long time. To prevent this, the system automatically dims the screen if a static picture is displayed for over 5 minutes (the screen saver function).

- Pressing any button will cancel the screen saver function.
- If you do not want to use the screen saver function, see page 49.

■ On-screen guide icons

During DVD playback, the following guide icons may appear for a while on the TV screen;

- : appears at the beginning of a scene containing multi-subtitle languages.
- : appears at the beginning of a scene containing multi-audio languages.
- : appears at the beginning of a scene containing multi-angle views.
- (Play), (Pause), / (Fast forward/fast-reverse), / (Slow-motion forward/reverse): appears when you perform each operation.
- If “⊙” appears on the TV screen when pressing a button, the disc cannot accept an operation you have tried to do or information required for that operation is not recorded to the disc.

NOTE

- In some cases, without showing “⊙”, operations will not be accepted.
- If you do not want the on-screen guide icons to appear, see page 51.

■ Playback information on the display window

DVD

Example: When a DVD encoded with Dolby Digital 5.1ch is played

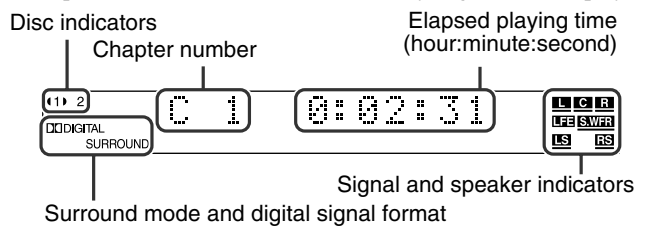

Each time FL DISPLAY is pressed, the indications alternate between those shown above and below.

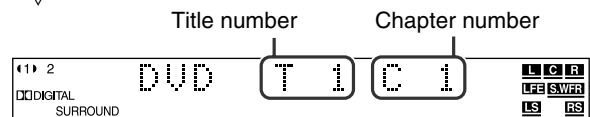

Video CD/SVCD/Audio CD

Example: When a Video CD is played back

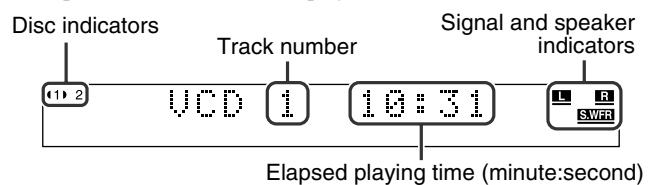

NOTE

- When a Video CD or SVCD with PBC function is played, the elapsed playing time does not appear, but “PBC” appears.

MP3 disc

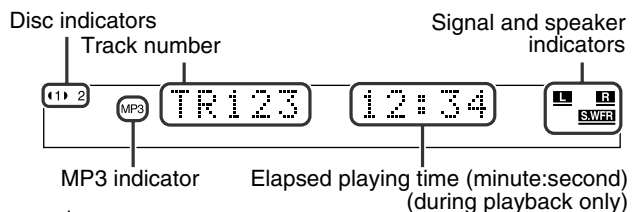

Each time FL DISPLAY is pressed, the indications alternate between those shown above and below.

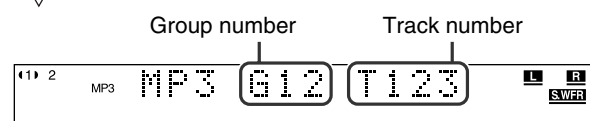

JPEG disc

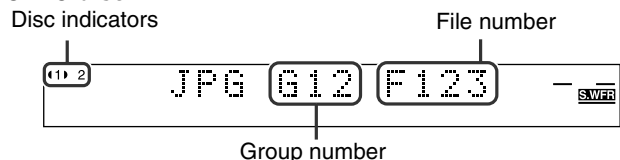

Playback

NOTE

- You can change the time information mode. (☞ pg. 34)
- You can also check the playback information on the TV screen. (☞ pg. 33)

■ Disc information on the display window

The disc indicators on the display window show the current status of the corresponding disc tray.

Example: When the discs are loaded to disc trays 1, 2 and 5, and the disc in the disc tray 5 is selected.

Currently loaded disc numbers

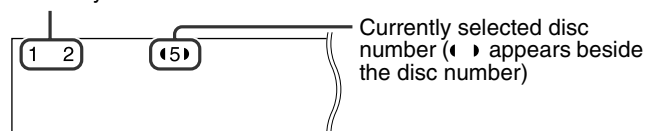

About the disc lamps (TH-M65 only)

The disc lamps on the center unit also show the disc status.

Disc	Lamp
Loaded	Red
Selected	Green
No disc	Off

NOTE

When loading a disc;

- Only after a DISC button is pressed the system starts reading the information of the disc on the specified tray. After that, the disc indicators/lamps (TH-M65 only) show the current disc status correctly.

■ Tray lock

You can lock trays and prohibit the unwanted disc ejection by children.

On the center unit ONLY:

While the system is turned off

Press and hold ■, then press ▲ for DISC 1.

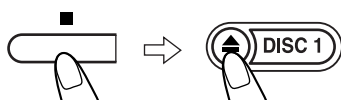

- The system turns on and "LOCKED" appears on the display window.
- If you try to eject discs, "LOCKED" appears and indicates that trays are locked.

To unlock trays

When the system is turned off, press and hold ■, then press ▲ for DISC 1.

- The system turns on and "UNLOCKED" appears on the display window.

Playback features

IMPORTANT

Before using the remote control for the following operation;

- Set the remote control mode selector to AUDIO.
- Press DVD.

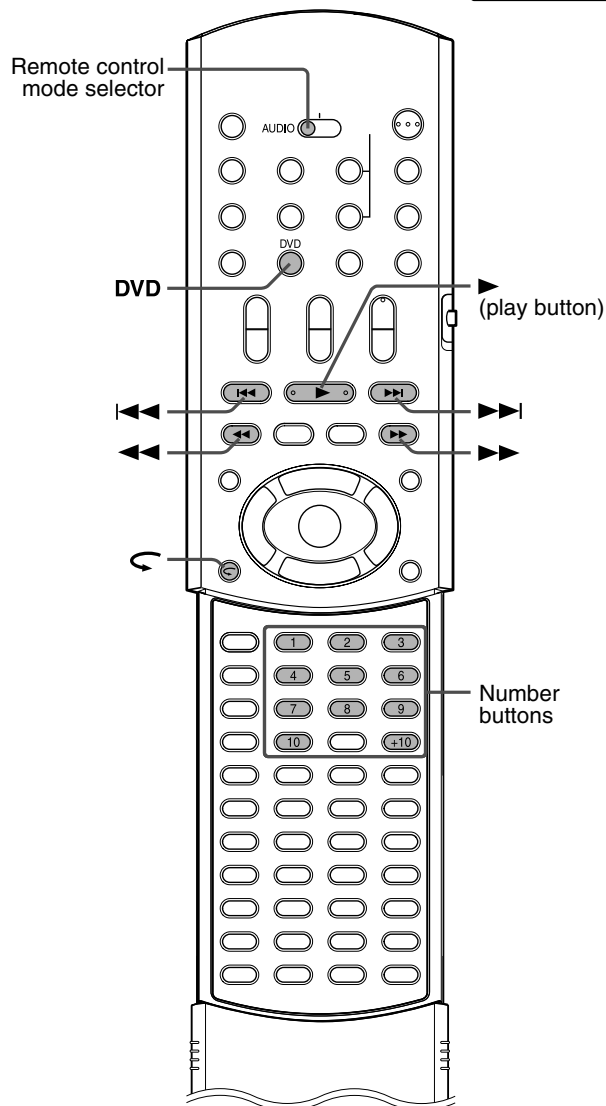
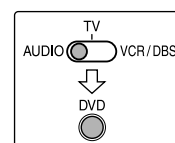

One Touch Replay

You can move back the playback position by 10 seconds from the current position.

DVD

- During playback

On the remote control:

Press ◀.

NOTE

- This function works between chapters in the same title.
- This function may not work for some DVDs.

Playback

Fast-forward/fast-reverse search

You can search for a particular point while playing a disc.



- During playback

On the remote control:

Press **▶▶/◀◀**.

Each time you press the button, the search speed changes as follows;

Forward:



Reverse:



* **▶▶ x60** and **◀◀ x60** are only available for DVD.

To return to normal speed playback

Press **▶** (play button).

On the remote control and the center unit:

Press and hold **▶▶|/|◀◀**.

Continuously pressing **▶▶|/|◀◀** increases the fast-forward/reverse search speed as follows;



To return to normal speed playback

Release the button.

NOTE

- When a DVD, Video CD or SVCD is played back, no sound comes out during fast-forward/reverse search.
- When an Audio CD is played back, sound is intermittent and low during fast-forward/reverse search.
- This function may not work for some DVDs.

Locating the beginning of a desired selection

You can locate the beginning of a chapter, track or file.



- For DVD (chapter): During playback
For Video CD/SVCD (track): During playback without PBC function
For Audio CD/MP3/JPEG (track/file): During playback or while stopped

To skip chapters, tracks or files forward

Press **▶▶|** as many times as required.

To skip to the beginning of the current chapter, track or file

Press **|◀◀** once.

To skip chapters, tracks or files backward

Press **|◀◀** as many times as required.

NOTE

- This function may not work for some DVDs.
- When playing a Video CD or SVCD with the PBC function, **▶▶|** and **|◀◀** may be used for the operations of menu-driven playback. (☞ pg. 4, 35)
- When playing back an MP3/JPEG disc, you can make operations using the MP3/JPEG control display. (☞ pg. 36, 37)

Locating a desired selection using number buttons

You can locate the desired title, chapter, track or file by selecting its number.



- For DVD (title, chapter):
While stopped (the title number is selected.)
During playback (the chapter number is selected.)
For Video CD/SVCD (track): During playback without PBC function
For Audio CD/MP3/JPEG (track/file): During playback or while stopped

On the remote control:

Press number buttons (1-10, +10) to select the desired title, chapter or track number.

Examples:

To select 3: Press **3**.

To select 14: Press **+10**, then **4**.

To select 24: Press **+10** twice, then **4**.

To select 40: Press **+10** three times, then **10**.

The specified title, chapter, track or file number appears on the display window and playback begins from that location.

NOTE

- While playing a DVD, if a menu is shown on the TV screen, number buttons may be used for selecting an item in the menu. (☞ pg. 34)
- While playing a Video CD or SVCD with the PBC function, if a menu is shown on the TV screen, number buttons are used for selecting an item in the menu. (☞ pg. 35)

Tuner operations

You can browse through all the stations or use the preset function to go immediately to a particular station.

IMPORTANT

Before using the remote control for the following operation;

- 1 Set the remote control mode selector to AUDIO.
- 2 Press FM/AM.

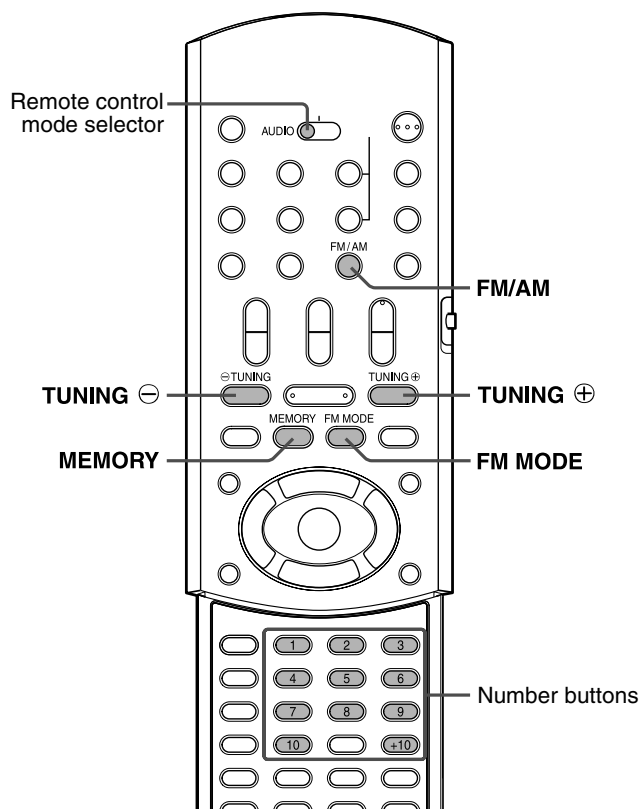
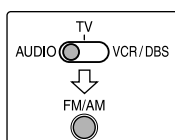

Setting the AM tuner interval spacing

Some countries space AM stations 9 kHz apart, and other countries use 10 kHz spacing.

- 10 kHz interval spacing is the initial setting.

On the center unit ONLY:

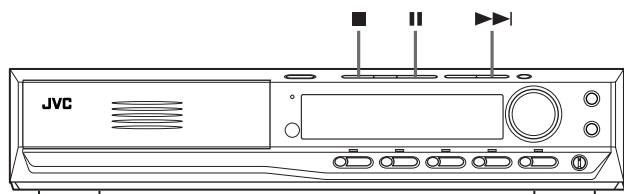

- When AM is selected as the source

To select the 10 kHz interval

Press and hold **10k**, then press **▶▶1**. "10k STEP" appears on the display window. Now the 10 kHz interval is selected.

To select the 9 kHz interval

Press and hold **9k**, then press **▶▶1**. "9k STEP" appears on the display window. Now the 9 kHz interval is selected.

Manual tuning

On the remote control:

1 Press FM/AM repeatedly to select the band.

Each time you press the button, the band alternates between FM and AM.

The selected band appears on the display window, then the last received station appears.

Example: When AM is selected

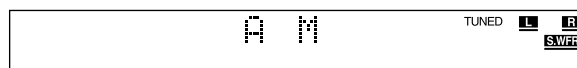

↓ After a few seconds

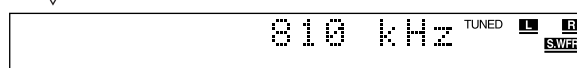

2 Press TUNING + or TUNING - repeatedly until you find the frequency you want.

When you hold down the button until the system starts searching for stations and then release it, the system stops searching automatically when a station of sufficient signal strength is tuned in to.

- TUNING +: Increases frequency.
- TUNING -: Decreases frequency.

NOTE

- When a station of sufficient signal strength is tuned in, the TUNED indicator lights on the display window.
- When an FM stereo program is received, the ST indicator lights on the display window.

Preset tuning

Once a station is assigned to a channel number, the station can be quickly tuned in. You can preset 30 FM and 15 AM stations.

■ To preset the stations

NOTE

Before you start operation;

- There is a time limit when doing the following steps. If the setting is cancelled before you finish, start from step 2 again.

1 Tune in the station you want to preset.

- For the detailed procedure, see "Manual tuning".
- If you want to store the FM reception mode for an FM station, select the reception mode you want. See "Selecting the FM reception mode" (pg. 28).

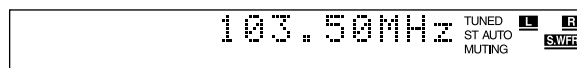

Tuner operations

2 Press MEMORY.

The channel number position starts flashing on the display window for about 5 seconds.

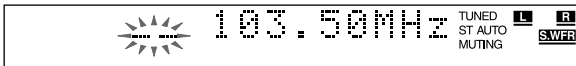

While the channel number position is flashing:

3 Press number button(s) (1-10, +10) to select a channel number.

The channel number and the CH indicator start flashing.

Examples:

For channel number 3: Press 3.

For channel number 14: Press +10, then 4.

(For FM stations only)

For channel number 24: Press +10 twice, then 4.

For channel number 30: Press +10 twice, then 10.

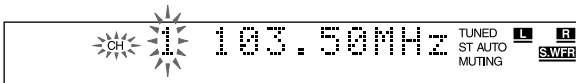

While the selected number is flashing:

4 Press MEMORY again.

The selected number stops flashing.

The station is assigned to the selected preset number.

5 Repeat steps 1 to 4 until you store all the stations you want.

To erase a stored preset station

Storing a new station to a used number erases the previously stored one.

■ To tune in to a preset station

On the remote control:

1 Press FM/AM repeatedly to select the band.

Each time you press the button, the band alternates between FM and AM.

2 Press number button(s) (1-10, +10) to select a preset channel number.

Examples:

For channel number 3: Press 3.

For channel number 14: Press +10, then 4.

(For FM stations only)

For channel number 24: Press +10 twice, then 4.

For channel number 30: Press +10 twice, then 10.

Selecting the FM reception mode

When the stereo FM program currently tuned in is noisy, you can change the FM reception mode to improve the reception.

- You can store the FM reception mode for each preset station. See "Preset tuning" (pg. 27).

- While listening to an FM station

On the remote control:

Press FM MODE.

The FM reception mode appears on the display window.

Each time you press the button, the FM reception mode alternates between "AUTO MUTING" and "MONO".

• AUTO MUTING:

When a program is broadcast in stereo, you will hear stereo sound. (The ST indicator lights on the display window.) When in monaural, you will hear monaural sound. This mode is also useful to suppress static noise between stations. The AUTO MUTING indicator lights on the display window.

• MONO:

Reception will be improved although you will lose the stereo effect. (The ST indicator goes off.) In this mode, you will hear noise until you are tuned in to a station. (The AUTO MUTING indicator also goes off.)

Reducing the noise of AM broadcast

When listening to an AM broadcast with a lot of noise interference, you can change the Beat Cut mode to reduce the noise.

- While listening to an AM station

On the remote control:

Press FM MODE.

The current Beat Cut mode appears on the display window.

Each time you press the button, the Beat Cut mode alternates between "BEAT CUT 1" and "BEAT CUT 2".

- Choose "BEAT CUT 1" or "BEAT CUT 2" according to which gives clearer sound.

Creating realistic sound fields

You can use the following surround modes to reproduce a realistic sound field.

- **Dolby Surround**
 - Dolby Pro Logic II
 - Dolby Digital
- **DTS Digital Surround**
- **DSP modes**
 - DAP modes
 - All Channel Stereo

■ Dolby Surround

Dolby Pro Logic II*

Dolby Pro Logic II has a newly developed multichannel playback format to decode all 2 channel sources — stereo source and Dolby Surround encoded source — into a 5.1 channel.

The matrix-based encoding/decoding method used by Dolby Pro Logic II makes no limitation for the cutoff frequency of the treble from surround channel and enables stereo surround sound compared to conventional Dolby Pro Logic.

Dolby Pro Logic II enables to reproduce spacious sound from original sound without adding any new sounds and tonal coloration. Dolby Pro Logic II has two modes — Movie mode and Music mode:

• Pro Logic II Movie (PL II MOVIE)

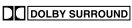
Suitable for reproduction of Dolby Surround encoded sources bearing the mark . You can enjoy soundfield very close to the one created with discrete 5.1 channel sounds.

• Pro Logic II Music (PL II MUSIC)

Suitable for reproduction of any 2 channel stereo music sources. You can enjoy wide and deep sound by using this mode.

- When Dolby Pro Logic II is activated, the  indicator lights on the display window.

Dolby Digital*

Used to reproduce multichannel soundtracks of the software encoded with Dolby Digital ().

Dolby Digital 5.1 ch (DOLBY D) encoding method (so-called discrete multichannel digital audio format) records and digitally compresses the front left channel, front right channel, center channel, surround left channel, surround right channel and LFE channel signals.

Since each channel is completely independent from the other channel signals to avoid interference, you can obtain much better sound quality with much stereo and surround effects.

NOTE

- Dolby Digital software can be roughly grouped into two categories—multichannel (up to “5.1” channel) and 2 channel software. To enjoy surround sounds while playing Dolby Digital 2 ch software, you can use Dolby Pro Logic II.

■ DTS Digital Surround**

Used to reproduce multichannel soundtracks of the software encoded with DTS Digital Surround ().

DTS Digital Surround (DTS) is another discrete multichannel digital audio format available on CD, LD and DVD software. Compared to Dolby Digital, audio compression ratio is relatively low. This fact allows DTS Digital Surround format to add breadth and depth to the reproduced sounds. As a result, DTS Digital Surround features natural, solid and clear sound.

■ DSP modes

DAP (Digital Acoustic Processor) modes

DAP modes have been designed to create important acoustic surround elements.

The sound heard in a live club, dance club, hall or pavilion consists of direct sound and indirect sound — early reflections and reflections from behind. Direct sounds reach the listener directly without any reflection. On the other hand, indirect sounds are delayed by the distances of the ceiling and walls (see the diagram below).

These indirect sounds are important elements of the acoustic surround effects. The DAP mode can reproduce a realistic sound field by adding these indirect sounds.

The following DAP modes are provided with this system.

LIVE CLUB	Gives the feeling of a live music club with a low ceiling.
DANCE CLUB	Gives a throbbing bass beat.
HALL	Gives clear vocal and the feeling of a concert hall.
PAVILION	Gives the spacious feeling of a pavilion with a high ceiling.

These DAP modes can be used to add the acoustic surround effects while reproducing 2 channel stereo source, and can give you a real “being there” feeling.

- When one of the DAP modes is selected, the DSP indicator lights on the display window.

* *Manufactured under license from Dolby Laboratories. “Dolby”, “Pro Logic” and the double-D symbol are trademarks of Dolby Laboratories.*

** *“DTS” and “DTS Digital Surround” are registered trademarks of Digital Theater Systems, Inc.*

Creating realistic sound fields

Creating sound field

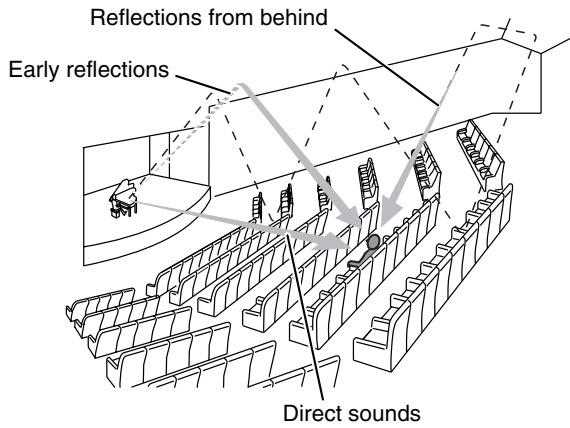

All Channel Stereo

All Channel Stereo (ALL CH ST.) mode can reproduce a larger stereo sound field using all the connected (and activated) speakers. All Channel Stereo can be used while reproducing 2 channel stereo source.

- When All Channel Stereo is selected, the DSP indicator lights on the display window.

All Channel Stereo reproduction

Normal stereo sound

All Channel Stereo

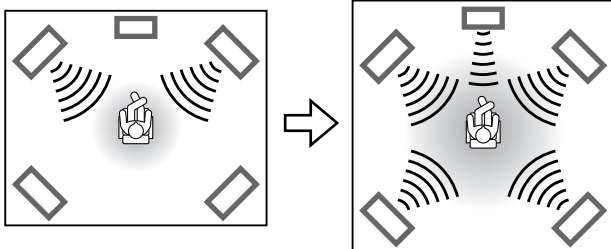

Indicators on the display window

Digital signal format indicators

- LPCM: Lights when Linear PCM signal comes in.
- DIGITAL: Lights when Dolby Digital signals come in.
- DTS: Lights when DTS Digital (Surround) signals come in.
- No indication: No digital signal indicator lights when analog signals come in.

NOTE

- While KARAOKE function is on, "LPCM" appears on the display window (TH-M65 only).

Source signal indicators, etc.

Light to indicate the incoming signals.

- L**: Lights when the left channel signal comes in.
- C**: Lights when the center channel signal comes in.
- R**: Lights when the right channel signal comes in.
- LFE**: Lights when the LFE channel signal comes in.
- LS**: Lights when the surround left channel signal comes in.
- RS**: Lights when the surround right channel signal comes in.
- S**: Lights when the monaural surround channel signal or 2 channel Dolby Surround signal comes in.
- S.WFR**: Always lights.



The channel with "—" shows that the corresponding speakers are reproducing the channels' sound.

If the channels' sound decoded into 5.1 channel is reproduced, only "—" lights.

Available Surround modes for each input signal

The ✓ marks show available surround modes.

Signal	Mode	Surround off (SURR OFF)	Dolby Surround			DTS Digital Surround (DTS)	DSP mode				
			PL II MOVIE*	PL II MUSIC*	Dolby Digital		DAP mode				ALL CH ST.*
							LIVE CLUB*	DANCE CLUB*	HALL*	PAVILION*	
Dolby Digital (Multichannel)		✓	—	—	✓	—	—	—	—	—	—
Dolby Digital (2 channel)		✓	✓	✓	—	—	—	—	—	—	—
DTS Digital Surround (Multichannel)		✓	—	—	—	✓	—	—	—	—	—
DTS Digital Surround (2 channel)		✓	✓	✓	—	—	—	—	—	—	—
Analog (VCR/FM/AM) or Linear PCM		✓	✓	✓	—	—	✓	✓	✓	✓	✓

* You can select these modes by pressing SURROUND (MODE). (pg. 31)

Creating realistic sound fields

IMPORTANT

Before using the remote control for the following operation;

- Set the remote control mode selector to AUDIO.

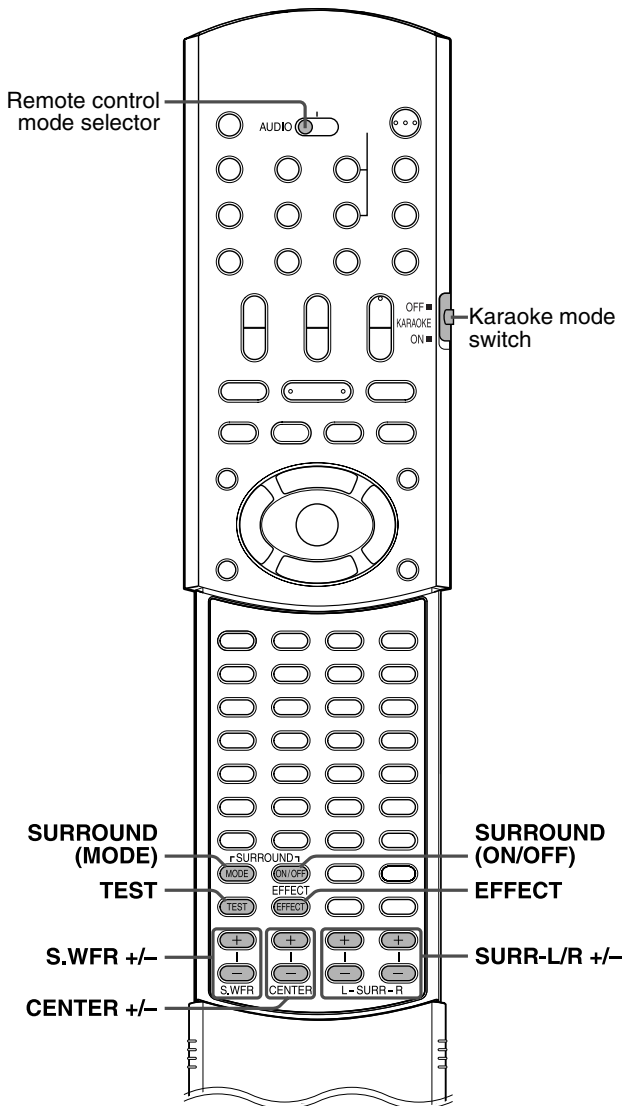
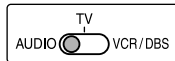

Using the surround mode

The system is set up to automatically select the optimal surround mode for input signal from digital multichannel software. When playing back 2 channel source, you can select the desired surround mode manually.

On the remote control:

■ When playing back digital multichannel software

The appropriate multichannel surround mode is automatically activated.

“DOLBY D”: When a software encoded with Dolby Digital is played back

“DTS”: When a software encoded with DTS Digital Surround is played back

In these cases, you can only turn on or off (“SURR OFF”) the surround mode.

■ When playing back 2 channel source

You can select either mode of Dolby Pro Logic II (PL II MOVIE/ PL II MUSIC) or one of the DSP modes (LIVE CLUB/DANCE CLUB/HALL/PAVILION/ALL CH ST.).

Press SURROUND (MODE).

The surround mode is turned on and the current surround mode appears on the display window.

Each time you press the button, the surround mode changes as follows;

⇒ PL II MOVIE ⇒ PL II MUSIC ⇒ LIVE CLUB ⇒ DANCE CLUB ⇒ HALL ⇒ PAVILION ⇒ ALL CH ST. ⇒ (back to the beginning)

For details on each mode, see pages 29 and 30.

To turn off the surround mode

Press SURROUND (ON/OFF).

Each time you press the button, the surround mode turns on and off alternately.

SURR OFF (surround off) = current selected mode (surround on)

NOTE

- When selecting “PL II MUSIC”, “PL II MOVIE”, “DOLBY D” or “DTS” as the surround mode, the SURROUND indicator lights.
- When selecting one of the DSP modes (“LIVE CLUB”/“DANCE CLUB”/“HALL”/“PAVILION”/“ALL CH ST.”) as the surround mode, the DSP indicator lights.
- For Dolby Digital 2 channel software, you can select “PL II MUSIC” or “PL II MOVIE”.

Storing adjustments — auto memory

This system memorizes the surround mode settings for each source.

- When you turn the power off:
When turning the power on again, the memorized settings for the current source are automatically recalled.
- When you change the source:
The memorized settings for the newly selected source are automatically recalled.

NOTE

- If the source is FM or AM, you can assign a different setting for each band.

Adjusting the sound

NOTE

Before you start operation;
 • Set the Karaoke mode switch to OFF. (for TH-M65 only)

On the remote control:

1 Press TEST.

Check if you can hear the sounds through all the speakers at the equal level.
 “TEST TONE” and the corresponding signal indicator starts flashing on the display window, and the test tone comes out of the speakers in the following order;



⇒ Front left speaker (FL) ⇒ Center speaker (C) ⇒ Front right speaker (FR) ⇒ Surround right speaker (SR) ⇒ Surround left speaker (SL) ⇒ (back to the beginning)

2 Adjust the speaker output levels (-10 to +10).

Adjust the center speaker and surround speaker levels as much as the sound from the front speakers. Use one of the following buttons to adjust each speaker level.

- CENTER +/- for the center speaker
- SURR-L +/- for the surround left speaker
- SURR-R +/- for the surround right speaker

3 Press TEST again to stop the test tone.

■ For DAP modes (pg. 29) only

4 Press EFFECT to select the effect level (1 to 5) you want.

Each time you press the button, the effect level changes as follows;

⇒ DSP EFFECT 1 ⇒ DSP EFFECT 2 ⇒ DSP EFFECT 3
 ⇒ DSP EFFECT 4 ⇒ DSP EFFECT 5 ⇒ (back to the beginning)

As the number increases, the selected mode will be more effective. (Normally set the level to “DSP EFFECT 3”.)

NOTE

- You cannot adjust the center speaker output level for the DAP modes and the effect level for All Channel Stereo.
- You can output the test tone in any surround mode, or even when surround mode is not activated.
- Speaker output levels whose source signal indicator is lit can be adjusted without pressing TEST.
- When selecting DVD as the source, you can also adjust the speaker output levels using the choice menu. (pg. 50)

Advanced operations

This section explains advanced operations for disc playback using the remote control.

- shows the types of discs an operation is available for.
- Turn on your TV and select the correct input mode on the TV.

NOTE

- If “⊘” appears on the TV screen when pressing a button, the disc cannot accept an operation you have tried to do or information required for that operation is not recorded to the disc.

Using the on-screen bar

You can check disc information while the disc is loaded and you can use some functions using the on-screen bar.

IMPORTANT

Before using the remote control for the following operation;

- 1 Set the remote control mode selector to **AUDIO**.
- 2 Press **DVD**.

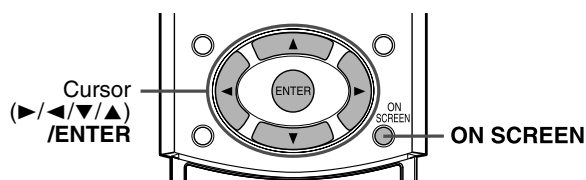
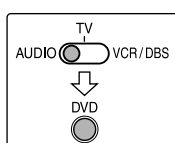

Showing the on-screen bar

- Whenever a disc is loaded



Press ON SCREEN.

Each time you press the button, the on-screen bar changes as follows on the TV screen.

Example: During DVD playback

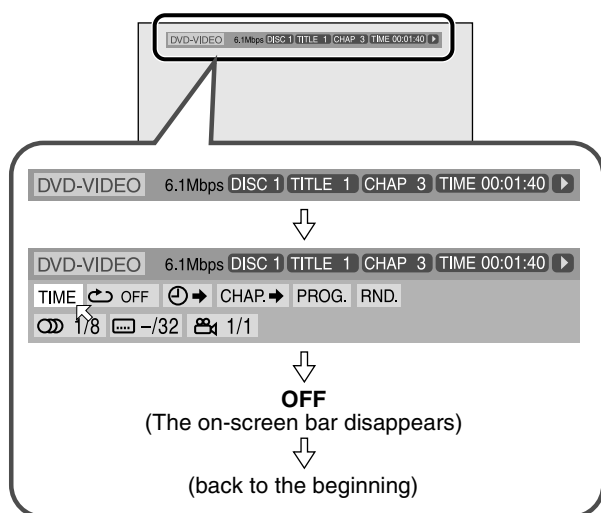

- The on-screen bar displays “NO-DISC” if no disc is loaded.

■ Contents of the on-screen bar during playback

DVD

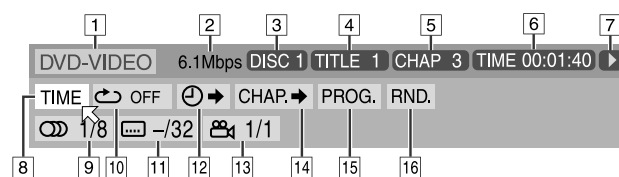

Video CD

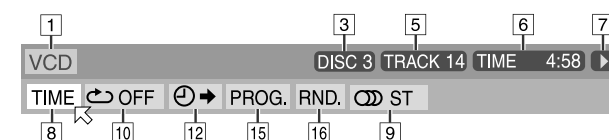

SVCD

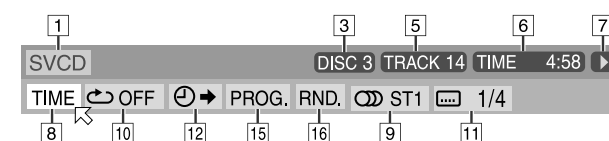

CD

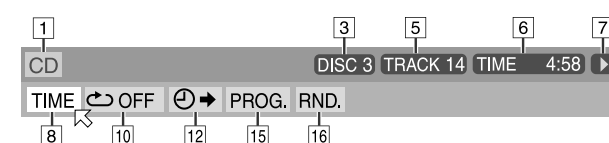

MP3 disc

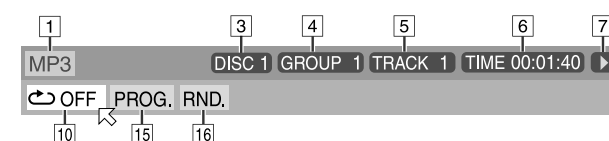

- 1 Shows disc type.
- 2 Shows current transfer rate (Megabits per second).
- 3 Shows disc number.
- 4 Shows current title (for DVD) or group (for MP3) number.
- 5 Shows current chapter number (for DVD) or track number (for other type of discs).
- 6 Shows time information. (⌚ pg. 34)
- 7 Shows playback status.
 - ▶: appears during playback.
 - ⏩ / ⏪: appears during fast forward/reverse.
 - ⏭ / ⏮: appears during playback in forward slow-motion/reverse slow-motion.
 - ⏸: appears when paused.
 - ⏹: appears when stopped.
- 8 Select this to change time information (6). (⌚ pg. 34)
- 9 Select this to change audio language or channel. (⌚ pg. 39, 40)
- 10 Select this for Repeat Playback. (⌚ pg. 44)
- 11 Select this to change subtitle language. (⌚ pg. 39)
- 12 Select this for time search function. (⌚ pg. 36)
- 13 Select this to change view angle. (⌚ pg. 38)
- 14 Select this for chapter search function. (⌚ pg. 35)
- 15 Select this for Program Playback. (⌚ pg. 43)
- 16 Select this for Random Playback. (⌚ pg. 44)

Advanced operations

Basic operation on the on-screen bar

Example: When selecting the Repeat mode of DVD

- During playback or while stopped

1 Press ON SCREEN twice.

The on-screen bar appears on the TV screen.

- The currently selected item shows green.



2 Press Cursor ►/◄ to move to .

3 Press ENTER.

The pop-up window appears under the selected item.

- The current setting appears.

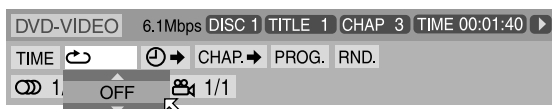

4 Press Cursor ▼/▲ to select the desired option.

Each time you press the button, the options change.

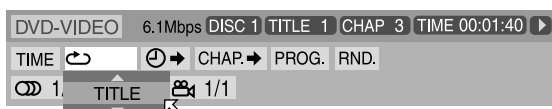

5 Press ENTER.

The setting changes and the pop-up window disappears.



To turn off the on-screen bar

Press ON SCREEN.

NOTE

- See the corresponding pages for details on each function.

Changing the time information

You can change the time information in the on-screen bar on the TV screen and the display window of the center unit.



- During playback or while stopped

1 Press ON SCREEN twice.

The on-screen bar appears on the TV screen.

2 Press Cursor ►/◄ to move to to TIME.

3 Press ENTER.

Each time you press the button, the time information changes as follows;

Example: During DVD playback

⇒ TIME 0:25:58 ⇒ REM 0:18:14 ⇒ TOTAL 1:25:58

⇒ T.REM 0:45:41 ⇒ (back to the beginning)

- TIME: Elapsed playing time of current chapter/track
- REM: Remaining time of current chapter/track
- TOTAL: Elapsed time of disc
- T. REM: Remaining time of disc

To turn off the on-screen bar

Press ON SCREEN.

NOTE

- While playing a Video CD, SVCD or Audio CD, the hour digit indication does not appear.

Playing from a specified position on a disc

You can start playing a title, chapter or track you specify. You can also play a disc from specified time.

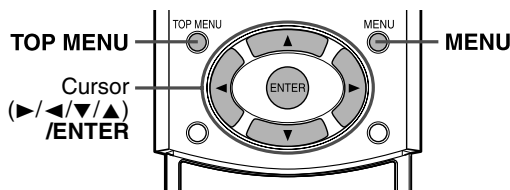

Locating a desired scene from the DVD menu

DVDs generally have their own menus which show disc contents. These menus contain various items such as titles of movies, names of songs or artist information, and you can display them on the TV screen. You can locate a desired scene by using these menus.

DVD

- Whenever a DVD is loaded

1 Press TOP MENU or MENU.

The menu appears on the TV screen.

Example:

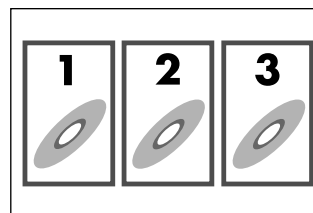

Normally, a DVD which contains more than one title will have a "title" menu which lists the titles. Press TOP MENU to show the title menu.

Some DVDs may also have a different menu which is shown by pressing MENU.

See the instructions for each DVD regarding its particular menu.

2 Use Cursor ►/◄/▼/▲ to select a desired item.

3 Press ENTER.

The system starts playback of the selected item.

- With some discs, you can also select items by entering the corresponding number using number buttons.

Advanced operations

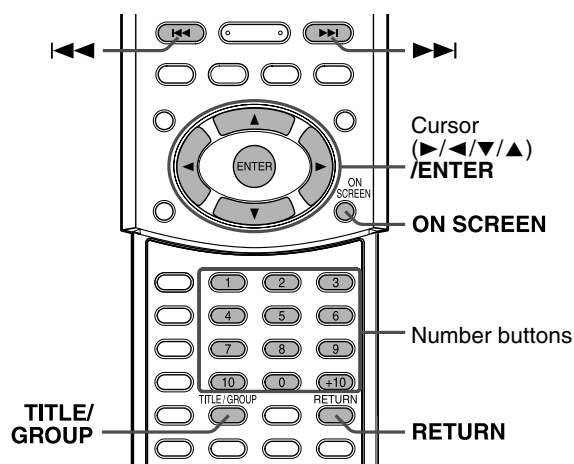

Locating a desired scene using a Video CD/SVCD menu with PBC

A Video CD or SVCD recorded with PBC has its own menus such as a list of contained songs. You can locate a specific scene by using these menus. (See pg. 4)



- When the menu appears on the TV screen during playback with PBC function

Press number buttons (1-10, +10) to select the number of the desired item.

The system starts playback from the selected item.

Example:

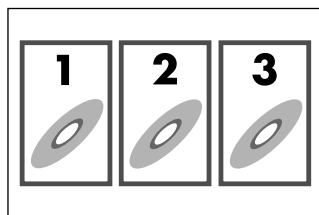

To select the number

Example:

- To select 3: Press 3.
- To select 11: Press +10, then 1.

To return to the menu

Press RETURN.

When "NEXT" or "PREVIOUS" is shown on the TV screen:

- To go to the next page, press ►►.
- To return to the previous page, press ◀◀.

NOTE

- If you want to play a PBC-compatible Video CD/SVCD without using the PBC function, perform any of the following:
 - Start playback by pressing number buttons while stopped.
 - Press ►► repeatedly until the desired track number is displayed, then start playback by pressing ► (play button). The track number appears on the display window instead of "PBC".
- To activate the PBC function when playing a PBC-compatible Video CD/SVCD without using the PBC function, perform any of the following:
 - Press TOP MENU or MENU.
 - Press ■ twice to stop playback, then press ► (play button).

Locating a desired chapter using the on-screen bar

When playing back a DVD, you can locate the chapter number to be played using the on-screen bar.



- During playback

1 Press ON SCREEN twice.

The on-screen bar appears on the TV screen.

2 Press Cursor ►/◀ to move to CHAP.►.

3 Press ENTER.

The following pop-up window appears under the selected item.

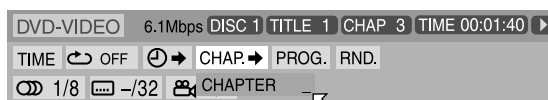

4 Press number buttons (0-10) to enter the desired chapter number.

Example:

- To select 8: Press 8.
- To select 10: Press 10.
- To select 20: Press 2, then 0.
- To select 37: Press 3, then 7.

To correct a misentry

Repeat step 4 until the correct number appears in the pop-up window.

5 Press ENTER.

The system starts playback from the selected chapter.

To turn off the on-screen bar

Press ON SCREEN.

NOTE

- The +10 button is not used by this function.
- You can select up to the 99th chapter.

Locating a desired title/group using number buttons

When playing back a disc with more than one title or one group, you can specify a desired title or group to be played using number buttons.



1 Press TITLE/GROUP.

"_ _" is shown in the title/group display area in the display window.

Example: During DVD playback

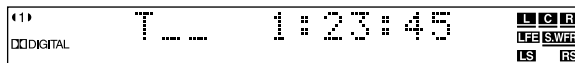

Advanced operations

2 Use number buttons (0-10, +10) to enter the desired title or group number.

The system starts playback from the first chapter/track/file of the selected title/group.

Example:

To select 8: Press 8.

To select 10: Press 10.

Or press +10, then 0.

To select 20: Press +10, then 10.

Or press +10 twice, then 0.

To select 25: Press +10 twice, then 5.

- Specify the number within 5 seconds after pressing TITLE/GROUP (i.e. while the display window shows “_” for the title/group number, instead of the current number).

- You can also specify the desired chapter/track/file by using number button. (☞ pg. 26)

NOTE

- This function may not work for some DVDs.

Locating a desired position by specifying the time

You can start playing at your desired position by specifying the elapsed playing time from the beginning of the current title (for DVD), or from the beginning of the disc (for Video CD/SVCD/Audio CD).



- For DVD:
During playback
- For Video CD/SVCD:
While stopped or during playback without PBC function
- For Audio CD:
During playback or while stopped

1 Press ON SCREEN twice.

The on-screen bar appears on the TV screen.

2 Press Cursor ▶/◀ to move ↻ to ⏮➡.

3 Press ENTER.

The following pop-up window appears under the selected item.



4 Use number buttons (0-9) to enter the time.

Example:

To play back from a point 2 (hours): 34 (minutes): 08 (seconds) elapsed

TIME _: _: _ ⇒ TIME 2: _: _ ⇒
Press 2 Press 3

TIME 2: 3 _: _ ⇒ TIME 2: 34: _ ⇒
Press 4 Press 0

TIME 2: 34: 0 _ ⇒ TIME 2: 34: 08
Press 8

To correct a misentry

Press Cursor ◀ repeatedly until the wrong number is erased, then press number buttons to enter the correct numbers.

5 Press ENTER.

The system starts playback from the specified time.

To turn off the on-screen bar

Press ON SCREEN.

NOTE

- You can also use the 10 button to enter “0”.
- The +10 button is not used by this function.
- You can specify time in hours/minutes/seconds for DVD and in minutes/seconds for Video CD/SVCD/Audio CD.

Using the MP3 control display

You can search and play desired groups and tracks using the MP3 control display.

■ MP3 control display

The MP3 control display appears on the TV screen and playback starts when a MP3 disc is selected.

Total group number on Current track Total track number in disc number current group

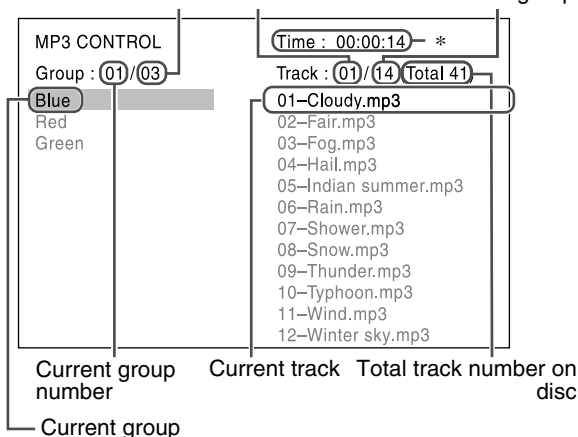

* Elapsed playing time of current track
Elapsed playing time is only shown during playback.

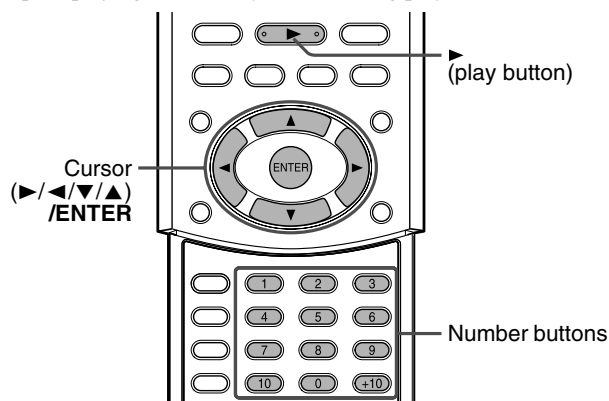

■ During playback

1 Press Cursor ▼/▲ to select the desired group.

2 Press Cursor ▶ to select the track list.

3 Press Cursor ▼/▲ to select the desired track.

The playback starts from the selected track.

If you select the track while stopped

Press ENTER or ▶ (play button) to start playback of the selected track.

Continued on next page

Advanced operations

To select the other group

Press Cursor ◀ to return to the group list, then press Cursor ▼/▲ to select the desired group.

To skip groups/tracks during playback

Press Cursor ▼ repeatedly for forward-skip.
Press Cursor ▲ repeatedly for reverse-skip.

To start playback by specifying the track number

Press number buttons (0-10, +10) to enter the track number.

Example:

To select 3: Press 3.

To select 14: Press +10, then 4.

To select 20: Press +10, then 10.

Or press +10 twice, then 0.

To select 24: Press +10 twice, then 4.

To select 110: Press +10 ten times, then 10.

The entered number appears in the track number indication and playback starts from the track you have specified.

NOTE

- You can also check playback information on the display window. (☞ pg. 24)
- Some group and track names may not be displayed correctly depending on recording conditions.
- The order of groups and tracks on an MP3 disc may be displayed differently from the order displayed on your personal computer.
- Up to 12 groups and tracks are displayed at once. Pressing Cursor ▼/▲ repeatedly scrolls the display to show the hidden groups and tracks one by one.

Using the JPEG control display

You can search and show desired groups and files using the JPEG control display.

■ JPEG control display

The JPEG control display appears on the TV screen when stopping playback of a JPEG disc.

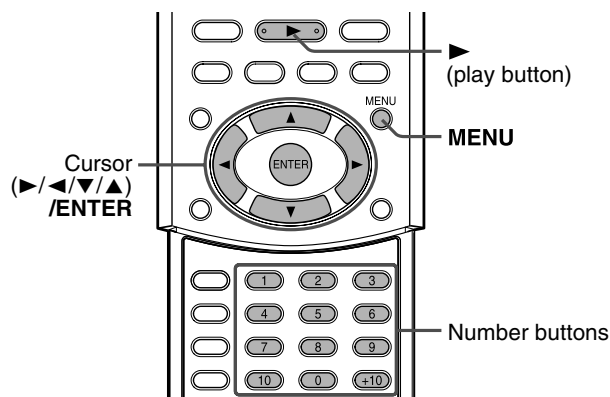
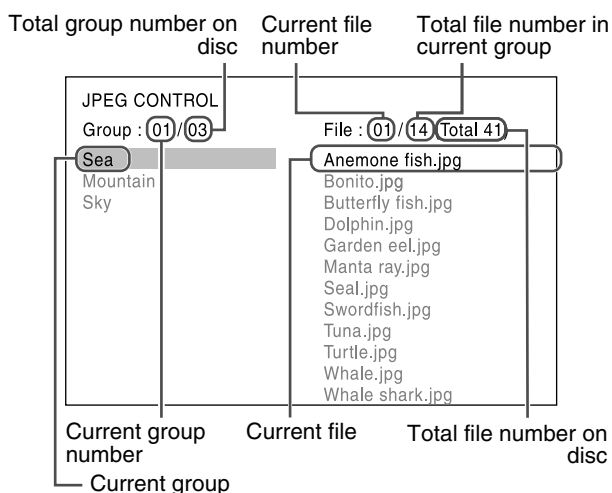

■ While stopped

1 Press Cursor ▼/▲ to select the desired group.

2 Press Cursor ▶ to select the file list.

3 Press Cursor ▼/▲ to select the desired file.

4 Press ▶ (play button) to start the slide-show playback from the selected file.

To show only the selected file

Press ENTER.

- When a still picture is completely shown on the TV screen, you can zoom in on areas in the still picture. (☞ pg. 41)

To select the other group

Press Cursor ◀ to return to the group list, then press Cursor ▼/▲ to select the desired group.

To start the slide-show playback by specifying the file number

Press number buttons (0-10, +10) to enter the file number.

Example:

To select 3: Press 3.

To select 14: Press +10, then 4.

To select 20: Press +10, then 10.

Or press +10 twice, then 0.

To select 24: Press +10 twice, then 4.

To select 110: Press +10 ten times, then 10.

The entered number appears in the file number indication and the slide-show playback starts from the file you have specified.

To return to the JPEG control display

Press MENU.

NOTE

- Some group and file names may not be displayed correctly depending on recording conditions.
- The order of groups and files on a JPEG disc may be displayed differently from the order displayed on your personal computer.
- Up to 12 groups and files are displayed at once. Pressing Cursor ▼/▲ repeatedly scrolls the display to show the hidden groups and files one by one.

Selecting a view angle of DVD

While playing back a DVD containing multi-view angles, you can enjoy the same scene at different angles.

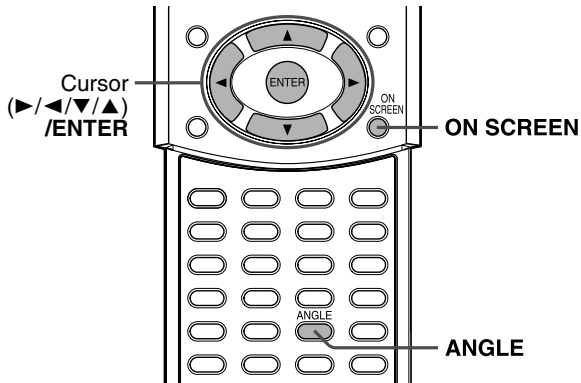

Selecting a view angle

■ During playback



When using the ANGLE button:

1 Press ANGLE.

The following pop-up window appears on the TV screen.

Example: The first view angle is selected out of 3 view angles recorded.

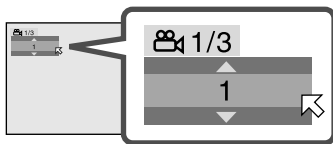

2 Press ANGLE repeatedly to select the desired view angle.

Each time you press the button, the angle of the scene changes.

Example:

⇒ 1/3 ⇒ 2/3 ⇒ 3/3 ⇒ (back to the beginning)

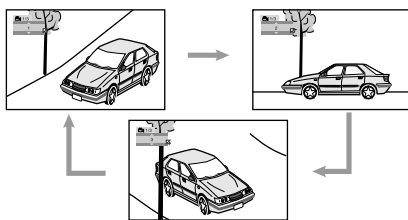

The pop-up window disappears if no operation is done for about 5 seconds.

When using the on-screen bar:

1 Press ON SCREEN twice.

The on-screen bar appears on the TV screen.

2 Press Cursor ►/◄ to move to [camera icon].

3 Press ENTER.

The following pop-up window appears under the selected item.

Example: The first view angle is selected out of 3 view angles recorded.

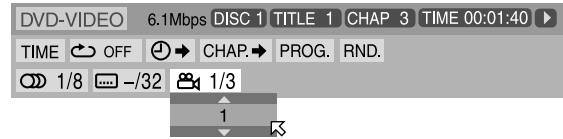

4 Press Cursor ▼/▲ repeatedly to select the desired view angle.

Each time you press the button, the angle of the scene changes.

5 Press ENTER.

The pop-up window disappears.

To turn off the on-screen bar

Press ON SCREEN.

Selecting the subtitle/ audio languages

When playing back a DVD (or SVCD) containing subtitles in several languages, you can select the subtitle language to be displayed on the TV screen.

When a DVD contains audio (sound track) in several languages, you can also select the language (sound track) to listen to.

- You can also select specific audio channel(s) on Video CDs/ SVCDs.

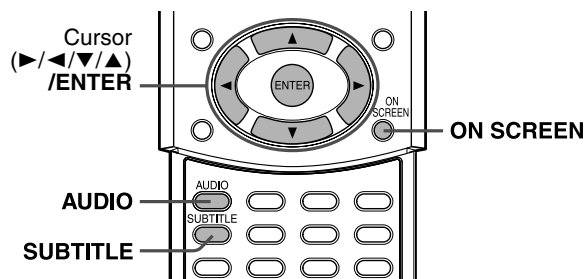

Selecting the subtitle language

- During playback

When using the **SUBTITLE** button:



1 Press SUBTITLE.

The following pop-up window appears on the TV screen.

Example (DVD): "ENGLISH" is selected out of 3 subtitle languages recorded.

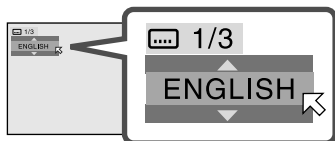

2 Press SUBTITLE repeatedly to select the desired subtitle language.

Each time you press the button, the subtitle language changes.

For SVCD

- An SVCD can contain up to four subtitles. Pressing SUBTITLE changes the subtitles regardless of whether the subtitles are recorded or not. (Subtitles will not change if no subtitle is recorded.)

The pop-up window disappears if no operation is done for about 5 seconds.

NOTE

- Some subtitle languages are abbreviated in the pop-up window. See "The language codes list" (pg. 48).

When using the on-screen bar:

1 Press ON SCREEN twice.

The on-screen bar appears on the TV screen.

2 Press Cursor ►/◀ to move to [] .

3 Press ENTER.

The following pop-up window appears under the selected item.

Example (DVD): "ENGLISH" is selected out of 3 subtitle languages recorded.



4 Press Cursor ▼/▲ repeatedly to select the desired subtitle language.

Each time you press the button, the subtitle language changes.

5 Press ENTER.

The pop-up window disappears.

To turn off the on-screen bar

Press ON SCREEN.

Selecting the audio language

- During playback



When using the **AUDIO** button:

1 Press AUDIO.

The following pop-up window appears on the TV screen.

Example: "ENGLISH" is selected out of 3 audio languages recorded.

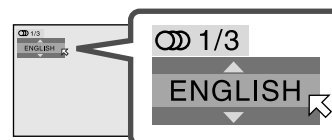

2 Press AUDIO repeatedly to select the desired audio language.

Each time you press the button, the audio languages change.

The pop-up window disappears if no operation is done for about 5 seconds.

NOTE

- Some audio languages are abbreviated in the pop-up window. See "The language codes list" (pg. 48).

When using the on-screen bar:

1 Press ON SCREEN twice.

The on-screen bar appears on the TV screen.

2 Press Cursor ►/◀ to move to [] .

3 Press ENTER.

The following pop-up window appears under the selected item.

Example: "ENGLISH" is selected out of 3 audio languages recorded.

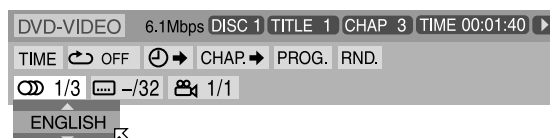

Advanced operations

4 Press Cursor ▼/▲ to select the desired audio language.

Each time you press the button, the audio language changes.

5 Press ENTER.

The pop-up window disappears.

To turn off the on-screen bar

Press ON SCREEN.

NOTE

- Some audio languages are abbreviated in the pop-up window. See "The language codes list" (☞ pg. 48).

Selecting the audio channel

When you play certain karaoke (Video CD/SVCD), you can enjoy karaoke by selecting the audio channel to play.



- The sound of each audio channel depends on the contents of the disc.

- During playback

When using the AUDIO button:

1 Press AUDIO.

The following pop-up window appears on the TV screen.

Example: "ST" (stereo) is selected out of 3 audio channels recorded.

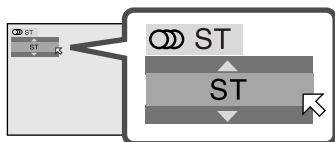

2 Press AUDIO repeatedly to select the desired audio channel.

Each time you press the button, the audio channel changes.

Example for Video CD:

⇒ ST ⇒ L ⇒ R ⇒ **(back to the beginning)**

- ST: To listen to normal stereo playback.
- L: To listen to L (left) audio channel only.
- R: To listen to R (right) audio channel only.

Example for SVCD:

⇒ ST 1 ⇒ ST 2 ⇒ L 1 ⇒ R 1 ⇒ L 2 ⇒ R 2 ⇒ **(back to the beginning)**

- ST 1/ST 2: To listen to normal stereo playback of ST 1 or 2 channel.
- L 1/L 2: To listen to L (left) 1 or 2 audio channel.
- R 1/R 2: To listen to R (right) 1 or 2 audio channel.

The pop-up window disappears if no operation is done for about 5 seconds.

When using the on-screen bar:

1 Press ON SCREEN twice.

The on-screen bar appears on the TV screen.

2 Press Cursor ►/◄ to move to .

3 Press ENTER.

The following pop-up window appears under the selected item.

Example: "ST" (stereo) is selected out of 3 audio channels recorded.

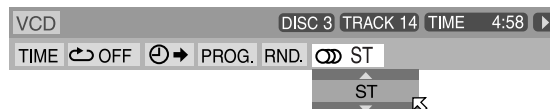

4 Press Cursor ▼/▲ to select the desired audio channel(s).

Each time you press the button, the audio channel changes.

5 Press ENTER.

The pop-up window disappears.

To turn off the on-screen bar

Press ON SCREEN.

Special picture playback

This system provides special picture playback functions including frame-by-frame, slow-motion and zoom.

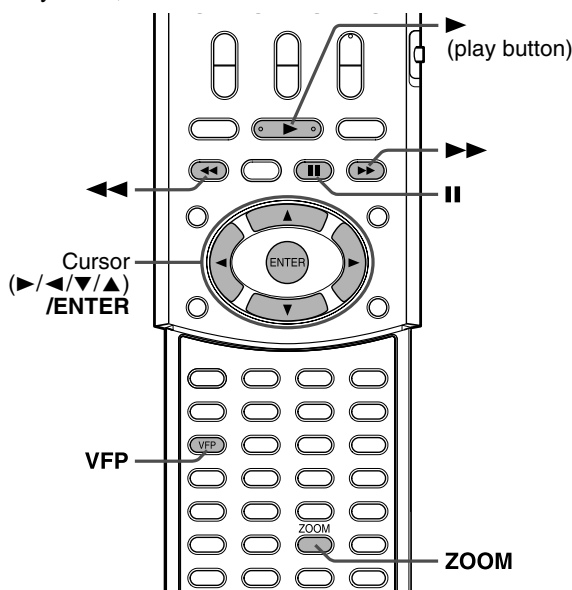

Frame-by-frame playback

■ During playback

Press II repeatedly.

Each time you press the button, the still picture advances by one frame.

To return to normal playback

Press ► (play button).

NOTE

- You can perform the above operation using the buttons on the center unit.

Playing back in slow-motion

■ During playback

1 Press II at the point where you want to start playback in slow-motion from.

The system pauses playback.

2 Press ►►.

- Playback in forward slow-motion starts.

For DVD only:

- To play back in reverse slow-motion, press ◀◀.

Each time you press the button, the playback speed become faster and on-screen guide icon changes as follows;

Forward:

⇒ ►► 1/32 ⇒ ►► 1/16 ⇒ ►► 1/8 ⇒ ►► 1/4 ⇒ ►► 1/2

Reverse:

⇒ ◀◀ 1/32 ⇒ ◀◀ 1/16 ⇒ ◀◀ 1/8 ⇒ ◀◀ 1/4 ⇒ ◀◀ 1/2

To pause slow-motion playback

Press II.

To return to normal playback

Press ► (play button).

NOTE

- Sound cannot be heard during slow-motion playback.

Zooming in

■ During playback or while paused

1 Press ZOOM.



Each time you press ZOOM, scene magnification changes as follows;

⇒ x 1 (normal size) ⇒ x 1.8 ⇒ x 4 ⇒ x 8 ⇒ x 16 ⇒ x 32 ⇒ x 64 ⇒ (back to the beginning)

Example: When x4 zoom is selected.

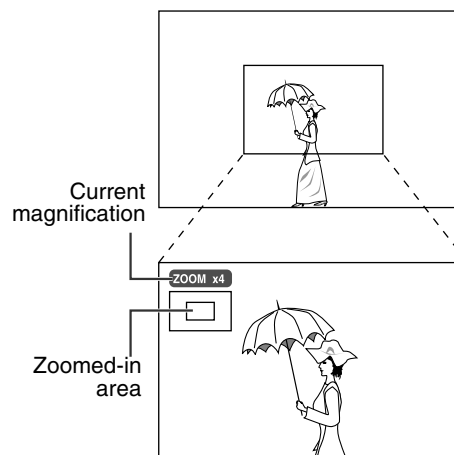

2 While zoomed in, press Cursor ►/◀/▼/▲ to move zoom-in area.

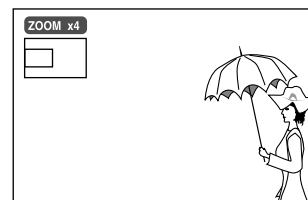

To return to normal playback

Press ENTER.

NOTE

- Picture may look coarse while zoomed in.
- During slide-show playback of a JPEG disc, zooming in is not available. In such a case, press II or ENTER to pause slide-show playback, then perform the procedure above to zoom in.

Changing the VFP setting

The VFP (Video Fine Processor) function enables you to adjust the picture character according to the type of programming, picture tone or personal preference.



NOTE

Before you start operation;

- The VFP setting screen disappears if no operations are done for more than about 10 seconds. If the setting screen disappears before you finish, start from step 1 again.

■ To select a VFP mode

1 Press VFP during playback.

The current VFP settings appear on the TV screen.

Example: When “NORMAL” is selected.

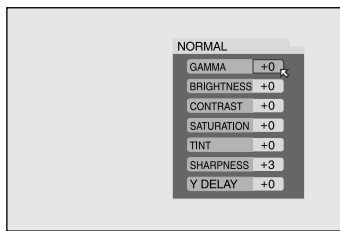

2 Press Cursor ▶/◀ repeatedly to select the VFP mode.

Each time you press the button, the VFP mode changes as follows;

⇄ NORMAL ⇄ CINEMA ⇄ USER 1 ⇄ USER 2 ⇄ (back to the beginning)

- NORMAL: Normally select this.
- CINEMA: Suitable for movies.
- USER 1 and USER 2:

You can adjust parameters that affect picture appearance and store settings. Go to step 3.

NOTE

- You cannot adjust the parameters of “NORMAL” and “CINEMA”. Press VFP to return to normal screen.

■ To adjust picture appearance manually

3 Press Cursor ▶/◀ repeatedly to select “USER 1” or “USER 2”.

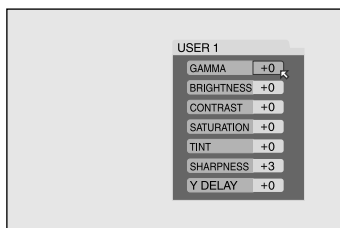

4 Press Cursor ▼/▲ repeatedly to select a parameter you want to adjust.

Adjust gradually and confirm picture appearance results are as preferred.

- GAMMA (−4 to +4): Controls brightness of neutral tints while maintaining brightness of dark and bright portions.
- BRIGHTNESS (−16 to +16): Controls screen brightness.
- CONTRAST (−16 to +16): Controls screen contrast.
- SATURATION (−16 to +16): Controls screen color depth.
- TINT (−16 to +16): Controls screen tint.
- SHARPNESS (+0 to +3): Controls screen sharpness.
- Y DELAY (−2 to +2): Controls screen color gap.

5 Press ENTER.

VFP menu disappears and the following pop-up window appears on the TV screen.

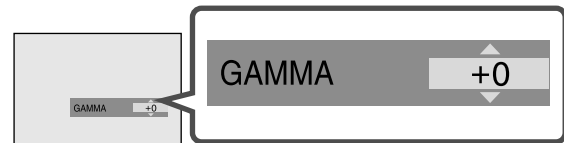

6 Press Cursor ▼/▲ repeatedly to change the setting.

7 Press ENTER.

The current VFP settings appear again.

8 Repeat steps 4 to 7 to adjust other parameters.

To return to the normal screen

Press VFP.

To activate your setting

Press VFP, then press Cursor ▶/◀ repeatedly to select “USER 1” or “USER 2” that you have changed the parameters.

Program Playback

You can play up to 99 titles (for DVD) or tracks (for other types of discs) in any order from among multiple discs. You may program the same title or track more than once.

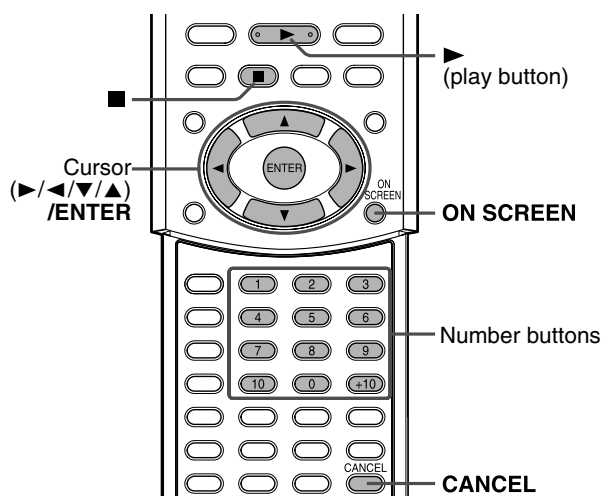

■ While stopped

1 Press ON SCREEN twice.

The on-screen bar appears on the TV screen.

2 Press Cursor ►/◄ to move to PROG..

3 Press ENTER.

The program menu appears on the TV screen.

- 10 orders appear at a time.

PROGRAM			
No.	Disc	Group	Track
1			
2			
3			
4			
5			
6			
7			
8			
9			
10			

4 ¹: When programming titles/tracks of DVD/Video CD/ SVCD/Audio CD

Press number buttons (1-10, +10) to specify selections by disc and title/track.

- At each program order use number buttons to specify source disc number first, press ENTER, then specify title/track number on source disc.

Example: To specify "title 3/track 3" of "disc 2"

Press 2 ⇒ ENTER* ⇒ 3

* You can also use any number buttons instead of ENTER.

(A number entered for a group number is invalid.)

When you specify the currently selected disc number (ⓘ pg. 25), skips group number column and moves to track number column automatically.

²: When programming tracks of MP3 disc

Press number buttons (1-10, +10) to specify selections by disc, group and track.

- At each program order use number buttons to specify source disc number first, specify group number, then specify track number on source disc.

Example: To specify "track 14" in "group 2" of "disc 3"

Press 3 ⇒ 2 ⇒ +10 ⇒ 4

Example for 4 ¹

PROGRAM			
No.	Disc	Group	Track
1	4	1	4
2	2		3
3	1		5
4	3	2	14
5	4	2	6
6			

Example for 4 ²

Selected title/track number

Selected group number

Selected disc number

5 Repeat step 4 to program following orders.

Each time you enter a title/track number in the order at the bottom of the program menu, the program menu scrolls and the following orders appear.

To erase an order

Press Cursor ▼/▲ to move to the order to be erased, then press CANCEL.

6 Press ► (play button) to start Program Playback.

When all of the programmed titles/tracks have been played back, playback stops and the program menu appears again. Note that program setting remains.

When playing back an Audio CD:

The program menu remains on the TV screen during Program Playback.

To check the program contents

During playback, press ■. Playback stops and the program menu appears.

To bring up the menu without stopping playback, carry out steps 1 to 3.

- You can also check playback status in the on-screen bar by pressing ON SCREEN.

To stop Program Playback

Press ■. Note that program setting remains.

To clear the program

While stopped and the program menu is shown on the TV screen, press ■.

All of the programmed titles/tracks are erased. You can also clear the program by turning off the system.

To quit the Program mode

After clearing all programmed titles/tracks, press ► (play button). The program menu disappears.

NOTE

- During Program Playback, you cannot edit program contents.
- During Program Playback, pressing ► skips to the next program selection. Pressing ◀ returns playback to the beginning of the current selection.
- The Resume function cannot be used with Program Playback.
- To close the program menu: Press ON SCREEN. The program menu is closed and the on-screen bar is shown.
- To turn off the on-screen bar: Press ON SCREEN repeatedly.
- Program Playback function cannot be used during Video CD/SVCD playback with PBC function.
- If you want to repeat the programmed titles/tracks, set the Repeat mode during Program Playback. (ⓘ pg. 44)
- Program Playback may not work for some discs.

Random Playback

You can play titles or tracks on a disc in random order.

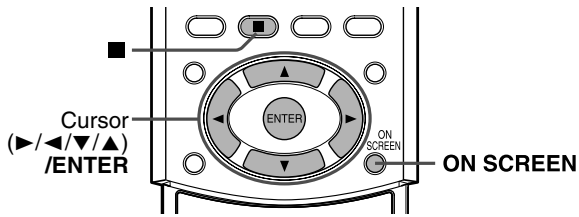

While stopped

1 Press ON SCREEN twice.

The on-screen bar appears on the TV screen.

2 Press Cursor $\blacktriangleright/\blacktriangleleft$ to move RND.

Example: For Audio CD

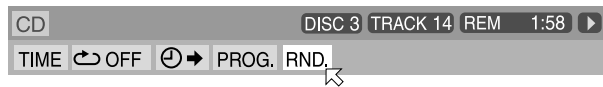

3 Press ENTER.

The system starts Random Playback. After playing all titles/tracks on the disc, the system stops playback and quits the Random mode. When more than one discs are loaded, the system starts Random Playback of the next disc after completing current disc playback.

To stop and quit Random Playback

Press \blacksquare . You can also clear the Random mode by turning off the system.

NOTE

- The same title/track will not be played back more than once during Random Playback.
- To return to normal playback without stopping playback, carry out steps 1 to 3 above.

Repeat Playback

You can repeat playback of the currently selected title or chapter (for DVD), track (for Video CD/SVCD/Audio CD), current group (for MP3/JPEG) or track (for MP3).

You can also repeat playback of a desired part.

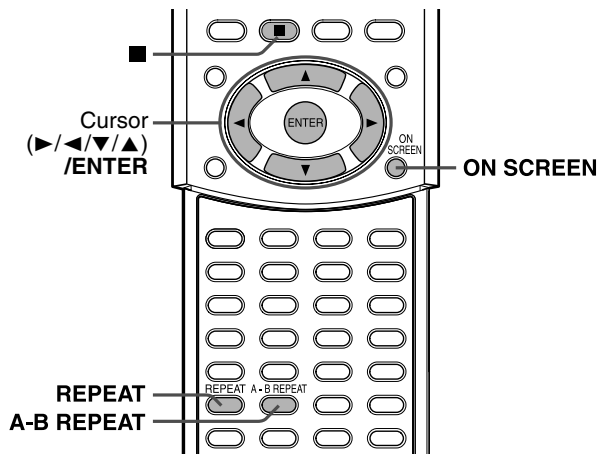

Repeating the current selection or all discs

- For DVD/Audio CD/MP3/JPEG: During playback
- For Video CD/SVCD: During playback without PBC function



When using the REPEAT button:

1 Press REPEAT.

Each time you press REPEAT, the Repeat mode changes cyclically.

- Repeat mode indicators appear on the display window and a repeat mode indication appears on the TV screen.



Repeat mode indicator

Followings are the description of indicators on the display window and indications on the TV screen.

Indicators	Indications	Meanings
RND.	REPEAT GROUP*	Repeats the current group for MP3/JPEG disc.
	TITLE	Repeats the current title for DVD.
	DISC	Repeats all tracks on the current disc for Video CD/SVCD/Audio CD/MP3.
	REPEAT DISC*	
	ALL	Repeats all the available discs.
REPEAT ALL*		
1	TRACK	Repeats the current track for Video CD/SVCD/Audio CD/MP3 disc.
	REPEAT TRACK	
	CHAP	Repeats the current chapter for DVD.
No indication	OFF	Repeat mode is off. The system plays back all available discs normally.

* During playback of a JPEG disc, "REPEAT GROUP", "REPEAT DISC" and "REPEAT ALL" do not appear on the TV screen.

To stop Repeat Playback

- Press \blacksquare .
- When a disc except DVD is selected, the system stops playback but does not quit the Repeat mode.
 - When a DVD is set, the system stops playback and quits the Repeat mode.

To quit the Repeat mode

- Press REPEAT until the Repeat mode indicator goes off from the display window.
- You can also clear the Repeat mode by changing the current disc except when in repeat all mode (ALL).

Advanced operations

NOTE

- If you press REPEAT while stopped, you need to press ► (play button) to start Repeat Playback.
- When the Program mode is active with a Video CD, SVCD, Audio CD, the Repeat mode changes in the same manner. Note that, however, in the “◀” mode the system repeats all the programmed tracks, instead of all tracks on the disc.
- During playback in the Repeat mode of the title/chapter/group/track, if you skip the title/chapter/group/track using ►/|/◀◀, etc., the destination title/chapter/group/track is repeated.
- If Ⓞ appears when pressing REPEAT during DVD playback, you cannot repeat the title or chapter because of disc contents.

When using the on-screen bar (except for JPEG disc):

1 Press ON SCREEN twice.

The on-screen bar appears on the TV screen.

2 Press Cursor ►/◀ to move ⏮ to ⏪.

3 Press ENTER.

The following pop-up window appears under the selected item.

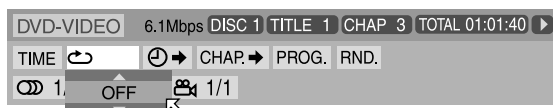

4 Press Cursor ▼/▲ repeatedly to select the Repeat mode.

- You can select the Repeat modes as follows:

For DVD

⏮ CHAPTER ⏮ TITLE ⏮ ALL ⏮ A-B ⏮ OFF ⏮ (back to the beginning)

For Video CD/SVCD/Audio CD

⏮ TRACK ⏮ DISC ⏮ ALL ⏮ A-B ⏮ OFF ⏮ (back to the beginning)

For MP3 disc

⏮ TRACK ⏮ GROUP ⏮ DISC ⏮ ALL ⏮ OFF ⏮ (back to the beginning)

5 Press ENTER.

To turn off the on-screen bar

Press ON SCREEN.

To cancel Repeat Playback

Repeat from step 1, select “OFF” in step 4, then press ENTER.

Repeating a desired part

You can repeat playback of a desired part by specifying the beginning (point A) and ending (point B).



- During playback

When using the A-B REPEAT button:

1 Press A-B REPEAT at the beginning of the part you want to repeat (point A).

The repeat mode indicator “◀ A ↔” appears on the display window.

2 Press A-B REPEAT again at the end of the part you want to repeat (point B).

The repeat mode indicator on the display window changes to “◀ A ↔ B” and A-B Repeat Playback starts. The selected part of the disc (between point A and B) is played repeatedly.



To cancel A-B Repeat Playback

Press A-B REPEAT during A-B Repeat Playback.

When using the on-screen bar:

1 Press ON SCREEN twice.

The on-screen bar appears on the TV screen.

2 Press Cursor ►/◀ to move ⏮ to ⏪.

3 Press ENTER.

The following pop-up window appears under the selected item.

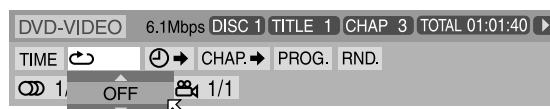

4 Press Cursor ▼/▲ repeatedly to select “A-B”.

5 Press ENTER at the beginning of the part you want to repeat (point A).

The following display appears in the on-screen bar.



6 Press ENTER at the end of the part you want to repeat (point B).

A-B Repeat Playback starts. The selected part of the disc (between point A and B) is played repeatedly.

To turn off the on-screen bar

Press ON SCREEN.

To cancel A-B Repeat Playback

Repeat from step 1, select “OFF” in step 4, then press ENTER.

NOTE

- When playing back a DVD, A-B Repeat Playback is possible only within the same title.
- “A-B” cannot be selected during Program and Random Playback.
- “A-B” cannot be selected while stopped.

Setting DVD preferences

You can adjust the initial settings for DVD playback according to your preference or needs using 5 choice menus shown on the TV screen.

- Adjustments are possible only when selecting DVD as the source.

Using the choice menus

- Turn on your TV and select the correct input mode on the TV.
- You can only use the remote control for choice menu operations.
- You can change the language used in the choice menus. (pg. 48)
- You cannot show the choice menus when an MP3 disc or a JPEG disc is accessed.

Choice menus

A: Language menu (LANGUAGE) (pg. 48)

You can select the initial languages for the disc menu, audio and subtitles.

You can also select the language used on the TV screen while operating this system.

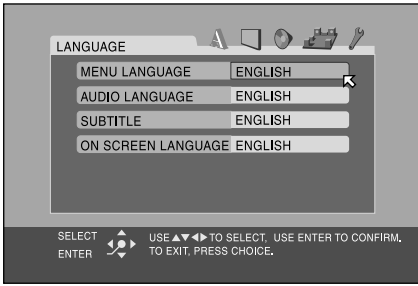

P: Picture menu (PICTURE) (pg. 49)

You can select the desired options concerning a picture or monitor screen.

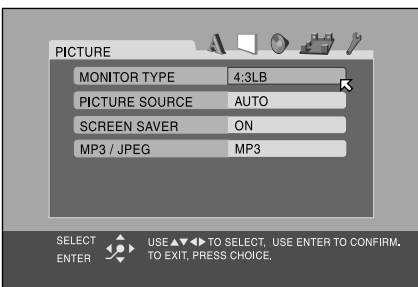

A: Audio menu (AUDIO) (pg. 49)

You can adjust sound settings.

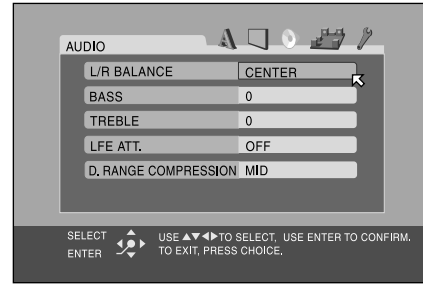

S: Speaker setting menu (SPK. SETTING) (pg. 50)

You can make speaker settings according to the size and layout of your speakers.

You can also adjust the output level of the subwoofer, center speaker and surround speakers.

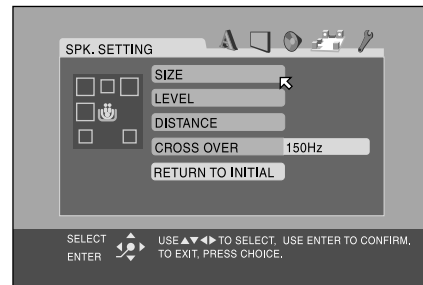

W: Other setting menu (OTHERS) (pg. 51)

You can change settings for some of the functions. Also use this menu to set Parental Lock.

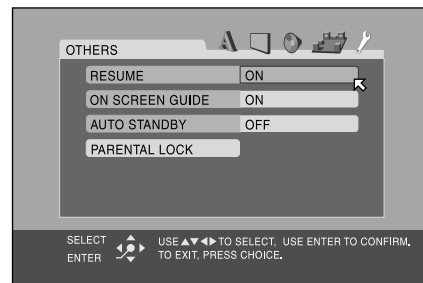

Setting DVD preferences

Basic operation on the choice menus

IMPORTANT

Before using the remote control for the following operation;

- 1 Set the remote control mode selector to AUDIO.
- 2 Press DVD.

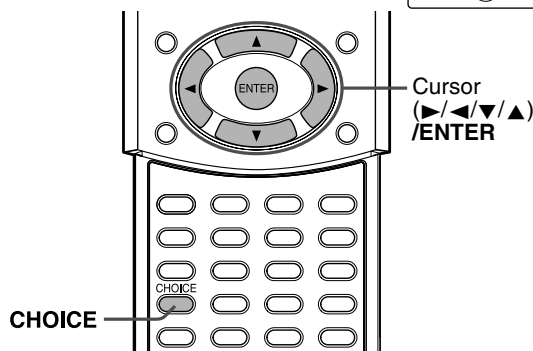
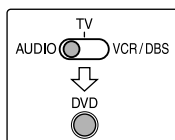

1 Press CHOICE.

The language menu (LANGUAGE) appears on the TV screen.

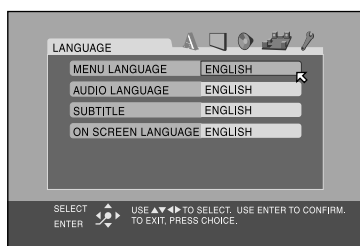

2 Press Cursor ►/◀ repeatedly to display one of the choice menus.

Each time you press the button, the choice menus change as follows;

LANGUAGE ⇄ PICTURE ⇄ AUDIO ⇄ SPK. SETTING ⇄ OTHERS ⇄ (back to the beginning)

Example: When the picture menu (PICTURE) is selected.

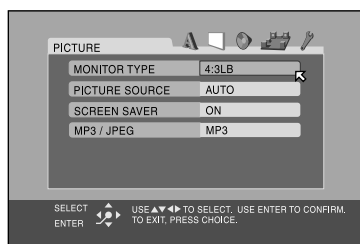

3 Press Cursor ▼/▲ repeatedly to move to the item you want to set up.

Example: When "PICTURE SOURCE" is selected.

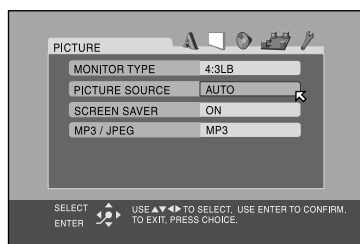

4 Press ENTER.

The pop-up window, listing the selectable options, appears on the choice menu.

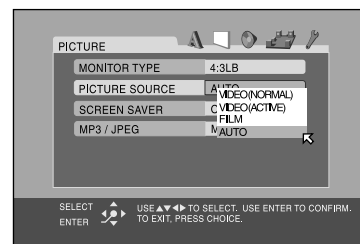

5 Press Cursor ▼/▲ repeatedly to select the desired option.

Example: When "FILM" is selected.

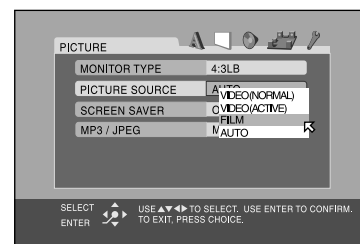

6 Press ENTER.

Your choice is stored.

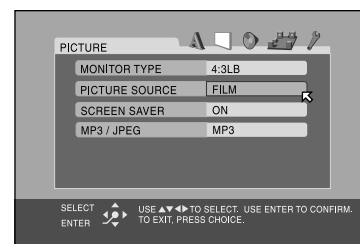

To set other items on the same choice menu

Repeat steps 3 to 6.

To move to another choice menu

Press Cursor ►/◀ repeatedly to select a choice menu you want to set up.

To return to the normal screen

Press CHOICE.

NOTE

- Some items in the choice menus consist of sub-menus to set up. Selecting these items and pressing ENTER makes its related sub-menu appear on the TV screen. You can set submenus using Cursor ►/◀/▼/▲ and ENTER (as explained in this basic operation).

Menu description

A: Language menu (LANGUAGE)

NOTE

- You can select "MENU LANGUAGE", "AUDIO LANGUAGE" and "SUBTITLE" only while playback is stopped.

■ MENU LANGUAGE

Some DVDs have their own menus in multiple languages.

- Select the initial language*.

ENGLISH, SPANISH, FRENCH, CHINESE, GERMAN, ITALIAN, JAPANESE and language codes from AA to ZU (see below)

■ AUDIO LANGUAGE

Some DVDs have multiple audio languages.

- Select the initial audio language*.

ENGLISH, SPANISH, FRENCH, CHINESE, GERMAN, ITALIAN, JAPANESE and language codes from AA to ZU (see below)

■ SUBTITLE

Some DVDs have multiple subtitle languages.

- Select the initial subtitle language*.

OFF (no indication of subtitles), ENGLISH, SPANISH, FRENCH, CHINESE, GERMAN, ITALIAN, JAPANESE and language codes from AA to ZU (see below)

■ ON SCREEN LANGUAGE

- Select the language shown on the TV screen when operating this system.

ENGLISH, CHINESE and SPANISH

- * When the language you have selected is not recorded to a disc, the original language is automatically used as the initial language.

The language codes list

AA	Afar	GL	Galician
AB	Abkhazian	GN	Guarani
AF	Afrikaans	GU	Gujarati
AM	Ameharic	HA	Hausa
AR	Arabic	HI	Hindi
AS	Assamese	HR	Croatian
AY	Aymara	HU	Hungarian
AZ	Azerbaijani	HY	Armenian
BA	Bashkir	IA	Interlingua
BE	Byelorussian	IE	Interlingue
BG	Bulgarian	IK	Inupiak
BH	Bihari	IN	Indonesian
BI	Bislama	IS	Icelandic
BN	Bengali, Bangla	IW	Hebrew
BO	Tibetan	JI	Yiddish
BR	Breton	JW	Javanese
CA	Catalan	KA	Georgian
CO	Corsican	KK	Kazakh
CS	Czech	KL	Greenlandic
CY	Welsh	KM	Cambodian
DA	Danish	KN	Kannada
DZ	Bhutani	KO	Korean (KOR)
EL	Greek	KS	Kashmiri
EO	Esperanto	KU	Kurdish
ET	Estonian	KY	Kirghiz
EU	Basque	LA	Latin
FA	Persian	LN	Lingala
FI	Finnish	LO	Laothian
FJ	Fiji	LT	Lithuanian
FO	Faroese	LV	Latvian, Lettish
FY	Frisian	MG	Malagasy
GA	Irish	MI	Maori
GD	Scots Gaelic	MK	Macedonian

ML	Malayalam	SO	Somali
MN	Mongolian	SQ	Albanian
MO	Moldavian	SR	Serbian
MR	Marathi	SS	Siswati
MS	Malay (MAY)	ST	Sesotho
MT	Maltese	SU	Sundanese
MY	Burmese	SV	Swedish
NA	Nauru	SW	Swahili
NE	Nepali	TA	Tamil
NL	Dutch	TE	Telugu
NO	Norwegian	TG	Tajik
OC	Occitan	TH	Thai
OM	(Afan) Oromo	TI	Tigrinya
OR	Oriya	TK	Turkmen
PA	Panjabi	TL	Tagalog
PL	Polish	TN	Setswana
PS	Pashto, Pushto	TO	Tonga
PT	Portuguese	TR	Turkish
QU	Quechua	TS	Tsonga
RM	Rhaeto-Romance	TT	Tatar
RN	Kirundi	TW	Twi
RO	Rumanian	UK	Ukrainian
RU	Russian	UR	Urdu
RW	Kinyarwanda	UZ	Uzbek
SA	Sanskrit	VI	Vietnamese
SD	Sindhi	VO	Volapuk
SG	Sangho	WO	Wolof
SH	Serbo-Croatian	XH	Xhosa
SI	Singhalese	YO	Yoruba
SK	Slovak	ZU	Zulu
SL	Slovenian		
SM	Samoan		
SN	Shona		

Setting DVD preferences

: Picture menu (PICTURE)

■ MONITOR TYPE

You can select the monitor type to match your TV when you play DVDs recorded in the picture's height/width ratio of 16:9.

- **16:9 NORMAL (Wide television conversion)**
Select this when the aspect ratio of your TV is fixed to 16:9 (wide TV).

The system automatically adjusts the screen width of the output signal correctly when playing back a picture whose aspect ratio is 4:3.

- **16:9 AUTO (Wide television conversion)**
Select this when the aspect ratio of your TV is 16:9 (wide TV).
- **4:3 LB (Letter Box conversion)**
Select this when the aspect ratio of your TV is 4:3 (conventional TV). While viewing a wide screen picture, the black bars appear on the top and the bottom of the screen.
- **4:3 PS (Pan Scan conversion)**
Select this when the aspect ratio of your TV is 4:3 (conventional TV). While viewing a wide screen picture, the black bars do not appear, however, the left and right edges of the pictures will not be shown on the screen.

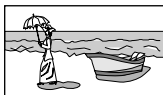

Ex.: 16:9



Ex.: 4:3 LB

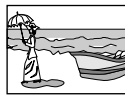

Ex.: 4:3 PS

- **16:9 MULTI NORMAL**
- **16:9 MULTI AUTO**
- **4:3 MULTI LB**
- **4:3 MULTI PS**

These "MULTI" options should be selected when you connect the system to a multi-color system TV. If you select one of these options, the system outputs a PAL or NTSC video signal according to the disc, regardless of the VIDEO OUT SELECT switch setting. (☞ pg. 8)

NOTE

- Even if "4:3 PS" is selected, the screen size may become "4:3 LB" with some DVDs. This depends on how DVDs are recorded.
- When you select "16:9 NORMAL" for a picture whose aspect ratio is 4:3, the picture slightly changes due to the process for converting the picture width.

■ PICTURE SOURCE

You can obtain optimal picture quality by selecting whether the content on the disc is processed by field (video source) or by frame (film source).

Normally set to "AUTO".

- **VIDEO (NORMAL)**
Suitable for playing back a video source disc with relatively a few movements.
- **VIDEO (ACTIVE)**
Suitable for playing back a video source disc with relatively a lot of movements.
- **FILM**
Suitable for playing back a film source disc.
- **AUTO**
Used to play a disc containing both video and film source materials.
This system recognizes the source type (video or film) of the current disc according to the disc information.
 - If the playback picture is unclear or noisy, or the oblique lines of the picture are rough, try to change to other modes.

■ SCREEN SAVER

You can activate or deactivate the screen saver function. (☞ pg. 24)

- **ON**
The picture on the TV screen becomes dark.
- **OFF**
Select this to deactivate the function.

■ MP3/JPEG

If both MP3 files and JPEG files are recorded on a disc, you can select which files to play.

- **MP3**
Select this to play MP3 files.
- **JPEG**
Select this to play JPEG files.

: Audio menu (AUDIO)

■ L/R BALANCE

You can adjust the balance between the front left and front right speakers.

L-21 to L-1 ⇄ CENTER ⇄ R-1 to R-21 (by 1 step)

- **CENTER**
The levels of the front left and right speakers are identical.
- **L-21 to L-1 and R-1 to R-21**
As the number increases, the level from one speaker lowered than that of the other speaker. (When you select "-21", no sound comes out from the selected (L or R) speaker.)

■ BASS

You can adjust the enhancement level for bass sound from the front speakers.

Within the range from -10 to +10. (by 2 step)

■ TREBLE

You can adjust the enhancement level for treble sound from the front speakers.

Within the range from -10 to +10. (by 2 step)

NOTE

- You can adjust bass/treble enhancement level only for front left/right channel. However, the supplied speakers cannot add the effective change to the bass sound because of their cutoff frequency even if the bass sound adjustment is made. (☞ pg. 50)
To change the bass enhancement level more efficiently, adjust the output level of the subwoofer. (☞ pg. 21)
(When you change the front speakers to the larger ones and select "LARGE" for the front speakers in the SIZE sub-menu (☞ pg. 50), the effective adjustment of bass sound is also possible.)

■ LFE ATT.

The Low Frequency Effect attenuator diminishes distortion of the bass sound from the subwoofer when playing back a disc with Dolby Digital or DTS Digital Surround.

- **ON**
Select this to diminish distortion of the bass sound from the subwoofer.
- **OFF**
Select this to deactivate the function.

■ D. RANGE COMPRESSION

(Dynamic range compression)

You can enjoy low level recorded sound clearly at night even at a low volume when listening to the sound with Dolby Digital.

- **MAX**
Select this when you want to fully apply the compression effect (useful at midnight).
- **MID**
Select this when you want to reduce the dynamic range a little.
- **OFF**
Select this when you want to enjoy surround sound with its full dynamic range (no effect applied).



Speaker setting menu (SPK. SETTING)

■ SIZE

Accesses the SIZE sub-menu (speaker size setting menu). (See following.)

■ LEVEL

Accesses the LEVEL sub-menu (speaker level setting menu). (See following.)

■ DISTANCE

Accesses the DISTANCE sub-menu (speaker distance setting menu). (See following.)

■ CROSS OVER*

Small speakers cannot reproduce bass sounds efficiently. If you use a small speaker in any position, this system automatically reallocates the bass sound elements assigned to the small speaker to one of the large speakers.

To use this function properly, set crossover frequency level according to the size of the smallest speaker connected.

• 200 Hz

Select this when the cone speaker unit in the smallest speaker connected is about 4 cm in diameter.

• 150 Hz (Select this when using the supplied speakers.)

Select this when the cone speaker unit in the smallest speaker connected is about 6 cm in diameter.

• 120 Hz

Select this when the cone speaker unit in the smallest speaker connected is about 8 cm in diameter.

• 100 Hz

Select this when the cone speaker unit in the smallest speaker connected is about 10 cm in diameter.

• 80 Hz

Select this when the cone speaker unit in the smallest speaker connected is about 12 cm in diameter.

* If you have selected "LARGE" for all speakers in the SIZE menu, this function will not take effect.

■ RETURN TO INITIAL

Resets all speaker settings to the initial settings.

■ Size menu (SIZE)

CAUTION

- When using the supplied speakers, select "SMALL" for each. Selecting "LARGE" may damage the speakers.

NOTE

- When "SMALL" is selected for the front speakers, you cannot select "LARGE" for the center speaker and surround speakers.

FRONT SPEAKER/CENTER SPEAKER/SURROUND SPEAKER

Select the speaker size according to the actual size of your speakers.

• LARGE

Select this when the cone speaker unit in the speaker is larger than 12 cm in diameter.

• SMALL (Select this when using the supplied speakers.)

Select this when the cone speaker unit in the speaker is smaller than 12 cm in diameter.

SUB WOOFER

USE

This item is fixed to "USE".

RETURN

Returns to the SPK. SETTING menu.

■ Level menu (LEVEL)

CENTER SPEAKER*/SURROUND LEFT SPEAKER*/SURROUND RIGHT SPEAKER*/SUB WOOFER

Adjust the output level of related speakers.

Within the range from -10 dB to +10 dB.

TEST TONE**

Outputs the test tone.

RETURN

Returns to the SPK. SETTING menu.

- You cannot select "CENTER SPEAKER" when one of the DAP modes (pg. 29) is selected as the surround mode. (pg. 31)
- You cannot select "CENTER SPEAKER", "SURROUND LEFT SPEAKER" and "SURROUND RIGHT SPEAKER" when the surround mode is off (stereo). (pg. 31)

** The test tone comes out of all of the activated speakers in the following sequence:

⇒ Front left speaker ⇒ Center speaker ⇒ Front right speaker ⇒ Surround right speaker ⇒ Surround left speaker ⇒ (back to the beginning)

■ Distance menu (DISTANCE)

Example:

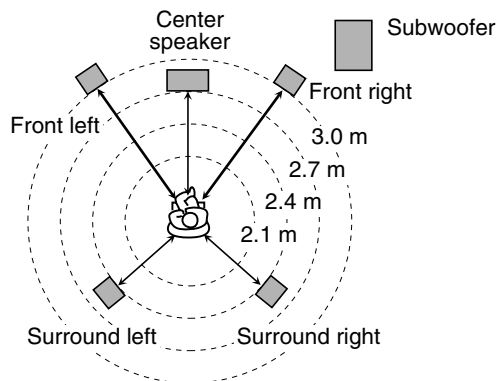

In this case, set the distance of each speaker as follows;

- Distance of front speakers: 3.0 m
- Distance of center speaker: 2.7 m
- Distance of surround speakers: 2.4 m

FRONT SPEAKER/CENTER SPEAKER/SURROUND SPEAKER

Adjust the distance from the listening position to the speakers.

Within the range from 0.3 m to 9.0 m (by 0.3 m)

TEST TONE*

Outputs the test tone.

RETURN

Returns to the SPK. SETTING menu.

* The test tone comes out of all of the activated speakers in the following sequence:

⇒ Front left speaker ⇒ Center speaker ⇒ Front right speaker ⇒ Surround right speaker ⇒ Surround left speaker ⇒ (back to the beginning)

Setting DVD preferences

Other setting menu (OTHERS)

NOTE

- You can select "PARENTAL LOCK" only while playback is stopped.

RESUME

You can activate or deactivate Resume Playback function.

- ON**
Select this to activate the function.
- OFF**
Select this to deactivate the function.

ON SCREEN GUIDE

You can activate or deactivate the on-screen guide icons.

( pg. 24)

- ON**
Select this to activate the function.
- OFF**
Select this to deactivate the function.

AUTO STANDBY*

When playback ends and does not restart for more than the time you specify, this system turns off by itself.

- 60**
This system turns off by itself if playback does not restart within 60 minutes.
- 30**
This system turns off by itself if playback does not restart within 30 minutes.
- OFF**
Select this to deactivate the function.

* When both the Auto Standby function and the Sleep Timer are activated, if the shut-off time set by the Sleep Timer comes earlier than the one set by the Auto Standby function, the Sleep Timer controls shut-off time.

PARENTAL LOCK

You can restrict playback of a DVD containing violent scenes that is not suitable for your other family members.

Accesses the PARENTAL LOCK sub-menu. (See following "Parental Lock".)

Parental Lock

Using this function, you can restrict playback of a DVD containing violent scenes or scenes not suitable for your other family members. Nobody can play such a disc unless this function is canceled.

- This setting takes effect only for DVDs containing the Parental Lock level information — Level 1 (most restrictive) to Level 8 (least restrictive).
- You can set the Parental Lock only when playback is stopped.

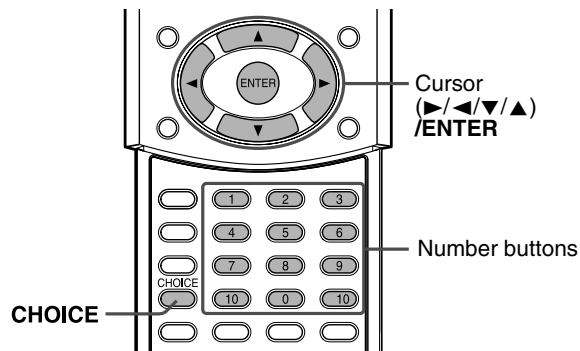

Setting Parental Lock

- Press **CHOICE**.
- Press **Cursor ▶/◀** to display the **OTHERS** menu.
- Press **Cursor ▼/▲** repeatedly to move  to "PARENTAL LOCK", then press **ENTER**.

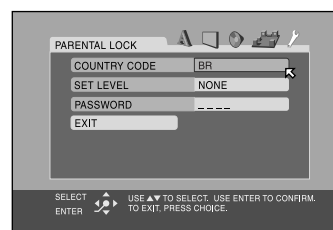

The PARENTAL LOCK sub-menu appears on the TV screen.

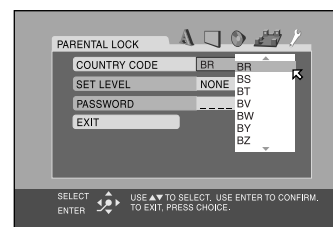

- Press **Cursor ▼/▲** repeatedly to move  to "COUNTRY CODE", then press **ENTER**.



- Press **Cursor ▼/▲** repeatedly to select the country code, then press **ENTER**.

See "Country/Area codes list for Parental Lock" ( pg. 53). The  moves to "SET LEVEL".

6 Press ENTER.

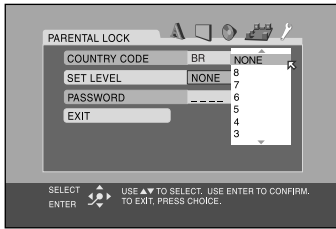

7 Press Cursor ▼/▲ repeatedly to select the level of restriction, then press ENTER.

The ⏏ moves to “PASSWORD”.
 • Select “NONE” to cancel this function.

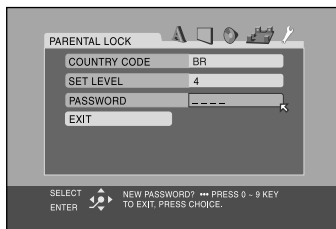

8 Press number buttons (0-9) to enter a four-digit number as your password, then press ENTER.

The ⏏ moves to “EXIT”.

9 Press ENTER.

The OTHERS menu resumes.

To return to the normal screen
 Press CHOICE.

NOTE

- Remember your password, or make a note of it.

Changing the Parental Lock setting

1 Press CHOICE.

2 Press Cursor ►/◀ to display the OTHERS menu.

3 Press Cursor ▼/▲ repeatedly to move ⏏ to “PARENTAL LOCK”, then press ENTER.

The PARENTAL LOCK sub-menu appears on the TV screen.
 • You can only move ⏏ to “PASSWORD” or to “EXIT” before you enter your password.

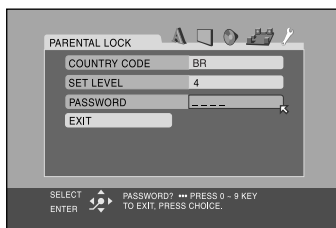

4 Press number buttons (0-9) to enter your password, then press ENTER.

- If you enter a wrong password, “WRONG! RETRY...” appears under the PARENTAL LOCK sub-menu. You cannot go to the next steps before you enter the correct password.

5 Press Cursor ▼/▲ repeatedly to move ⏏ to the item you want to change, then press ENTER.

6 Press Cursor ▼/▲ repeatedly to change the setting, then press ENTER.

7 Press number buttons (0-9) to enter your password, then press ENTER.

The new setting is stored.

NOTE

- You cannot set the Parental Lock before you set your password.
- If you go out of the PARENTAL LOCK sub-menu before setting your password in step 6, the new country code and parental lock level will not become effective. The old country code and parental level will remain in effect.
- When you enter wrong passwords more than three times, the ⏏ moves to “EXIT” automatically and Cursor ▼/▲ do not work. Press ENTER to exit from the PARENTAL LOCK sub-menu, then repeat from step 1.
- If you forget your password, enter “8888”.

Releasing Parental Lock temporarily

When you set a strict parental level, some discs may not be played back at all. When you load such a disc and try to play it, the following display appears on the TV screen. You can temporarily release the Parental Lock.

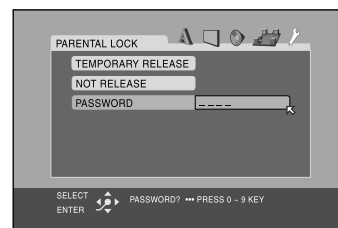

1 Press Cursor ▼/▲ repeatedly to move ⏏ to “TEMPORARY RELEASE”, then press ENTER.

The ⏏ moves to “PASSWORD”.

- When selecting “NOT RELEASE”, press one of ▲ buttons on the center unit to remove the disc.

2 Press number buttons (0-9) to enter your password.

Playback starts.

- If you enter a wrong password, “WRONG! RETRY...” appears under the PARENTAL LOCK sub-menu. You cannot play the disc before you enter the correct password.

NOTE

- When you enter wrong passwords more than three times, the ⏏ moves to “NOT RELEASE” automatically and Cursor ▼/▲ do not work. Press one of ▲ buttons on the center unit to remove the disc.

Setting DVD preferences

Country/Area codes list for Parental Lock

AD	Andorra	ER	Eritrea	LA	Lao People's Democratic Republic	RW	Rwanda
AE	United Arab Emirates	ES	Spain	LB	Lebanon	SA	Saudi Arabia
AF	Afghanistan	ET	Ethiopia	LC	Saint Lucia	SB	Solomon Islands
AG	Antigua and Barbuda	FI	Finland	LI	Liechtenstein	SC	Seychelles
AI	Anguilla	FJ	Fiji	LK	Sri Lanka	SD	Sudan
AL	Albania	FK	Falkland Islands (Malvinas)	LR	Liberia	SE	Sweden
AM	Armenia	FM	Micronesia (Federated States of)	LS	Lesotho	SG	Singapore
AN	Netherlands Antilles			LT	Lithuania	SH	Saint Helena
AO	Angola	FO	Faroe Islands	LU	Luxembourg	SI	Slovenia
AQ	Antarctica	FR	France	LV	Latvia	SJ	Svalbard and Jan Mayen
AR	Argentina	FX	France, Metropolitan	LY	Libyan Arab Jamahiriya	SK	Slovakia
AS	American Samoa	GA	Gabon	MA	Morocco	SL	Sierra Leone
AT	Austria	GB	United Kingdom	MC	Monaco	SM	San Marino
AU	Australia	GD	Grenada	MD	Moldova, Republic of	SN	Senegal
AW	Aruba	GE	Georgia	MG	Madagascar	SO	Somalia
AZ	Azerbaijan	GF	French Guiana	MH	Marshall Islands	SR	Suriname
BA	Bosnia and Herzegovina	GH	Ghana	ML	Mali	ST	Sao Tome and Principe
BB	Barbados	GI	Gibraltar	MM	Myanmar	SV	El Salvador
BD	Bangladesh	GL	Greenland	MN	Mongolia	SY	Syrian Arab Republic
BE	Belgium	GM	Gambia	MO	Macau	SZ	Swaziland
BF	Burkina Faso	GN	Guinea	MP	Northern Mariana Islands	TC	Turks and Caicos Islands
BG	Bulgaria	GP	Guadeloupe	MQ	Martinique	TD	Chad
BH	Bahrain	GQ	Equatorial Guinea	MR	Mauritania	TF	French Southern Territories
BI	Burundi	GR	Greece	MS	Montserrat	TG	Togo
BJ	Benin	GS	South Georgia and the South Sandwich Islands	MT	Malta	TH	Thailand
BM	Bermuda			MU	Mauritius	TJ	Tajikistan
BN	Brunei Darussalam	GT	Guatemala	MV	Maldives	TK	Tokelau
BO	Bolivia	GU	Guam	MW	Malawi	TM	Turkmenistan
BR	Brazil	GW	Guinea-Bissau	MX	Mexico	TN	Tunisia
BS	Bahamas	GY	Guyana	MY	Malaysia	TO	Tonga
BT	Bhutan	HK	Hong Kong	MZ	Mozambique	TP	East Timor
BV	Bouvet Island	HM	Heard Island and McDonald Islands	NA	Namibia	TR	Turkey
BW	Botswana			NC	New Caledonia	TT	Trinidad and Tobago
BY	Belarus	HN	Honduras	NE	Niger	TV	Tuvalu
BZ	Belize	HR	Croatia	NF	Norfolk Island	TW	Taiwan
CA	Canada	HT	Haiti	NG	Nigeria	TZ	Tanzania, United Republic of
CC	Cocos (Keeling) Islands	HU	Hungary	NI	Nicaragua	UA	Ukraine
CF	Central African Republic	ID	Indonesia	NL	Netherlands	UG	Uganda
CG	Congo	IE	Ireland	NO	Norway	UM	United States Minor Outlying Islands
CH	Switzerland	IL	Israel	NP	Nepal		
CI	Côte d'Ivoire	IN	India	NR	Nauru	US	United States
CK	Cook Islands	IO	British Indian Ocean Territory	NU	Niue	UY	Uruguay
CL	Chile	IQ	Iraq	NZ	New Zealand	UZ	Uzbekistan
CM	Cameroon	IR	Iran (Islamic Republic of)	OM	Oman	VA	Vatican City State (Holy See)
CN	China	IS	Iceland	PA	Panama	VC	Saint Vincent and the Grenadines
CO	Colombia	IT	Italy	PE	Peru		
CR	Costa Rica	JM	Jamaica	PF	French Polynesia	VE	Venezuela
CU	Cuba	JO	Jordan	PG	Papua New Guinea	VG	Virgin Islands (British)
CV	Cape Verde	JP	Japan	PH	Philippines	VI	Virgin Islands (U.S.)
CX	Christmas Island	KE	Kenya	PK	Pakistan	VN	Vietnam
CY	Cyprus	KG	Kyrgyzstan	PL	Poland	VU	Vanuatu
CZ	Czech Republic	KH	Cambodia	PN	Pitcairn	WF	Wallis and Futuna Islands
DE	Germany	KI	Kiribati	PR	Puerto Rico	WS	Samoa
DJ	Djibouti	KM	Comoros	PT	Portugal	YE	Yemen
DK	Denmark	KN	Saint Kitts and Nevis	PW	Palau	YT	Mayotte
DM	Dominica	KP	Korea, Democratic People's Republic of	PY	Paraguay	YU	Yugoslavia
DO	Dominican Republic			QA	Qatar	ZA	South Africa
DZ	Algeria	KR	Korea, Republic of	RE	Réunion	ZM	Zambia
EC	Ecuador	KW	Kuwait	RO	Romania	ZR	Zaire
EE	Estonia	KY	Cayman Islands	RU	Russian Federation	ZW	Zimbabwe
EG	Egypt	KZ	Kazakhstan				
EH	Western Sahara						

System setting

You can adjust the sound and speaker settings of this system.

- The adjustments on a source take effect for the other sources.

IMPORTANT

Before using the remote control for the following operation;

- Set the remote control mode selector to AUDIO.

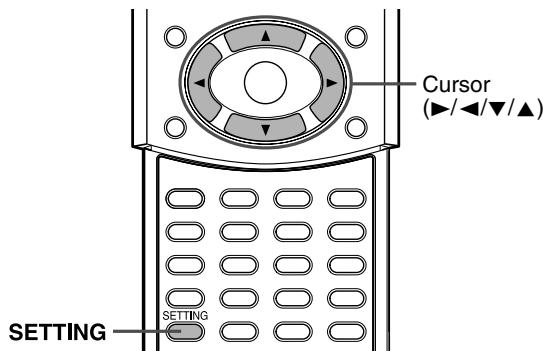
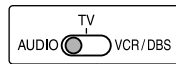

NOTE

Before you start operation;

- There is a time limit when doing the following steps. If the setting is cancelled before you finish, start from step 1 again.
- When selecting DVD as the source, the settings of the corresponding items in the choice menus also change.

On the remote control:

1 Press SETTING.

The item you last selected appears on the display window.

Example: "BAL" has been selected.



2 Press Cursor ▼/▲ repeatedly to select the item you want to set.

Each time you press the button, the items shown on the display window change as follows:

⇄ FRNT SP ⇄ CNTR SP ⇄ SURR SP ⇄ FRNT D ⇄ CNTR D ⇄ SURR D ⇄ CROSS ⇄ LFE ATT. ⇄ BAL ⇄ D. COMP ⇄ AUDIO POS ⇄ M. OUT ⇄ (back to the beginning)

See the corresponding pages for details on the related adjustments except for "AUDIO POS" and "M. OUT".

- FRNT SP (front speakers), CNTR SP (center speaker), SURR SP (surround speakers):
Select the size of each speaker. (pg. 50)
- FRNT D (front speakers distance), CNTR D (center speaker distance), SURR D (surround speakers distance):
Adjust distance from the listening position to the speakers. (pg. 50)
- CROSS:
Select the cutoff frequency of the subwoofer. (pg. 50)
- LFE ATT.:
Diminish the distortion of the bass sound from the subwoofer while playing back a disc with Dolby Digital or DTS Digital Surround. (pg. 49)

- BAL:
You can adjust the balance between the front left and front right speakers. (pg. 49)
- D. COMP (Dynamic Range Compression):
You can enjoy low level recorded sound clearly at night even at a low volume level when listening to the sound with Dolby Digital. (pg. 49)
- AUDIO POS (Audio Position):
Set the audio position of subwoofer so that the subwoofer level can be automatically adjusted properly. (The smaller the number becomes, the more the level decreases automatically when listening in stereo.)
- M. OUT (Monitor Out):
Select the video output jack type by which you watch DVD playback after connecting your TV. (pg. 8)
Set the video output to use AV COMPU LINK remote control system. (pg. 55)
- VIDEO: To watch DVD playback via the VIDEO jack.
S: To watch DVD playback via the S-VIDEO jack.
COMPNT (component):
To watch DVD playback via the COMPONENT VIDEO OUT jacks.

3 Press Cursor ►/◄ to make an adjustment or selection.

Example:



- FRNT SP, CNTR SP, SURR SP:
"SML" (small) ⇄ "LRG" (large)
- FRNT D, CNTR D, SURR D:
Within the range between 0.3 m and 9.0 m (by 0.3 m step)
- CROSS:
"80Hz" ⇄ "100Hz" ⇄ "120Hz" ⇄ "150Hz" ⇄ "200Hz" ⇄ (back to the beginning)
- LFE ATT.:
"ON" ⇄ "OFF"
- BAL:
"L-21" to "L-1" ⇄ "CENTER" ⇄ "R-1" to "R-21"
- D. COMP:
"MID" ⇄ "MAX" ⇄ "OFF" ⇄ (back to the beginning)
- AUDIO POS:
"0" ⇄ "-2" ⇄ "-4" ⇄ "-6" ⇄ (back to the beginning)
- M. OUT:
"VIDEO" ⇄ "S" ⇄ "COMPNT" ⇄ (back to the beginning)

4 Repeat steps 2 and 3 to set other items.

NOTE

- If you selected "SML" for the front speakers, you cannot select "LRG" for the center and surround speakers.
- You can confirm your adjustment of speaker settings by listening to the test tone. To output the test tone, press TEST. (pg. 32)

AV COMPU LINK remote control system

The AV COMPU LINK remote control system allows you to operate JVC TVs and VCRs through the center unit. This system is equipped with the AV COMPU LINK-III, which adds a function to operate JVC's video components via the video components terminals. To use this remote control system, you need to connect the video components you want to operate as follows.

- Refer also to the manuals supplied with your TV and video components.

AV COMPU LINK

Connecting a TV and VCR

CAUTION

Before connecting;

- If you have already plugged your VCR, TV and the center unit into the AC outlets, unplug their AC power cords first.

1 Connect the center unit to a TV and VCR.

- For details, see page 8 and 14.

2 Connect the center unit to a TV and VCR using the optional AV COMPU LINK cords.

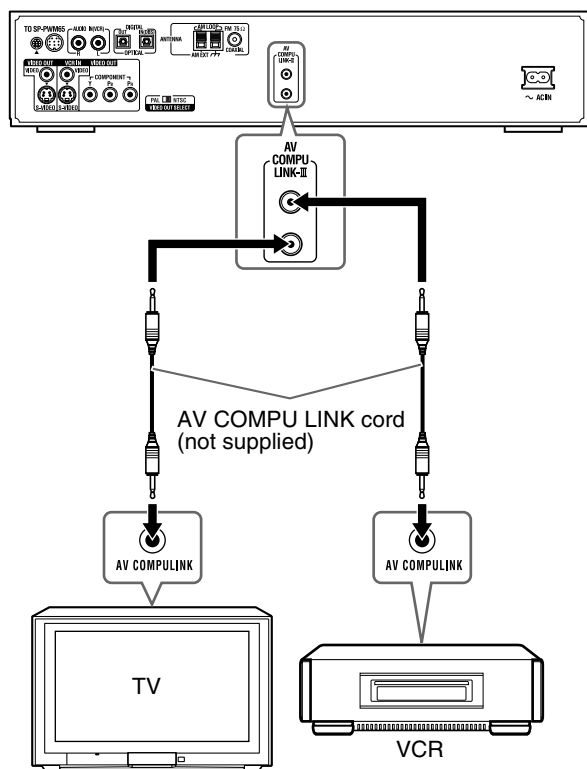

3 Plug the AC power cords of the VCR, TV and the center unit into the AC outlets.

4 Turn on the connected components first, then turn on the center unit.

- When turning on the TV for the first time after the AV COMPU LINK connection, turn the TV volume to minimum using the TV volume control on the TV.
- When turning on the VCR, use the remote control supplied with this system. (Press \odot /VCR/DBS.)

NOTE

- To correctly use the automatic selection of TV input mode, select the correct "M. OUT" setting. (pg. 54)

Available functions

The AV COMPU LINK remote control system allows you to use the functions listed following.

One-touch video play

Simply by inserting a video cassette without its safety tab into the VCR, you can enjoy video playback without manually setting other switches. This system automatically turns on and changes the source to VCR.

The TV automatically turns on and changes the input mode to the appropriate position so that you can view the playback picture. When you insert a video cassette with its safety tab in place, press the play (▶) button on the VCR or on the remote control to get the same result.

One-touch DVD play

Simply by starting playback on the built-in DVD player, you can enjoy playback without manually setting other switches. The TV automatically turns on and changes the input mode to the appropriate position so that you can view the playback picture.

Automatic selection of TV input mode

When you select DVD or VCR as the source to play on the system, the TV automatically changes the input mode to the appropriate position so that you can view the playback picture.

Automatic Power On/Off

The TV and VCR turn on and off along with the system.

When you turn on the system;

- If the previously selected source is "DVD", only the TV will turn on automatically.
- If the previously selected source is "VCR", the TV and VCR will turn on automatically.





When you turn off the system, the TV and VCR will turn off.

NOTE

- If you turn off the system while recording on the VCR, the VCR will not turn off and will continue recording.



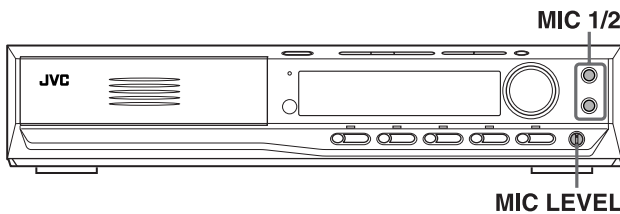
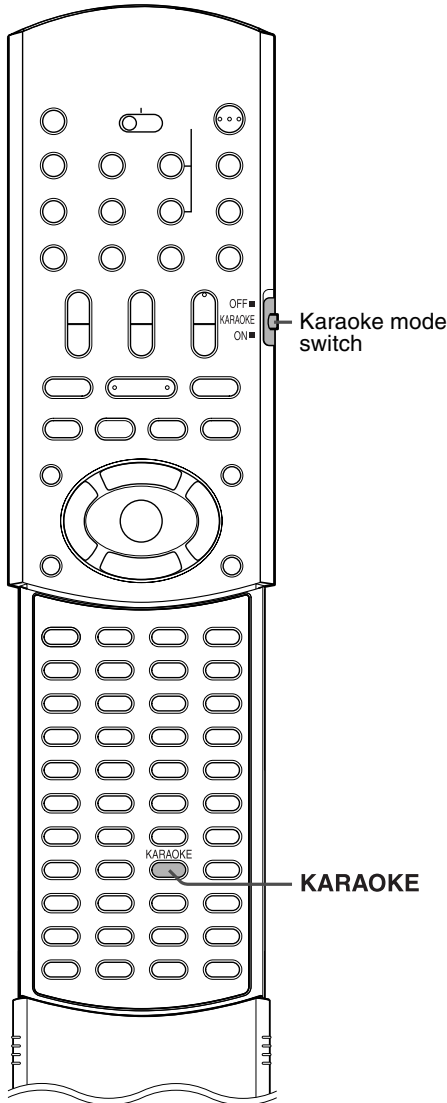

KARAOKE operations (TH-M65 only)

This section explains various KARAOKE features including echo and chorus effects, etc. to enjoy singing along with Karaoke disc.

-     shows the types of discs an operation is available for.
- Turn on your TV and select the correct input mode on the TV.
- Turn the system on. See “Turning the system on/off” (pg. 19).



Basic KARAOKE operation

- 1 Set the Karaoke mode switch to ON.**    
- 2 Connect a microphone to MIC 1 or MIC 2 on the center unit.**
- 3 Press the KARAOKE button so that “KARAOKE” appears on the display window.**
- 4 Start playback.**
See “Basic playback” (pg. 23).
- 5 Turn MIC LEVEL to adjust the microphone’s volume.**
 - Turn MIC LEVEL clockwise to turn up and counterclockwise to turn down the volume. This control adjust the output volume of both MIC 1 and MIC 2 together.
- 6 Sing along with the playback of the song.**

To turn off KARAOKE function

Press KARAOKE so that “KARAOKE” disappears from the display window.

To repeat a disc/chapter/title/ track during KARAOKE mode

Set the Repeat mode. (pg. 44)

To enjoy Karaoke using a menu screen

See “Playing from a specified position on a disc” (pg. 34).

NOTE

- While playback is paused, no sound (voice) via the microphone is heard from the speakers.
- You cannot turn on KARAOKE function while playing back an MP3/JPEG disc.
- KARAOKE function will be canceled when you change the source by pressing a source selecting button or when an MP3/JPEG disc playback automatically starts. (In the later case, when you eject the MP3/JPEG disc or a disc other than MP3/JPEG disc playback starts, KARAOKE function will resume.)
- When KARAOKE function is on:
 - The on-screen bar (for functions other than KARAOKE) or choice menu does not appear on the TV screen.
 - Program and random play cannot be set.
 - VFP setting and zooming are not available.
 - The volume indication on the display window automatically turns up by six levels but the change of the indication does not affect on the hearing.
 - The output level of the DIGITAL OUT jack will be lowered.

KARAOKE operations (TH-M65 only)

IMPORTANT

Before using the remote control for the following operation;

- 1 Set the Karaoke mode switch to ON.
- 2 Press the KARAOKE button so that "KARAOKE" appears on the display window.

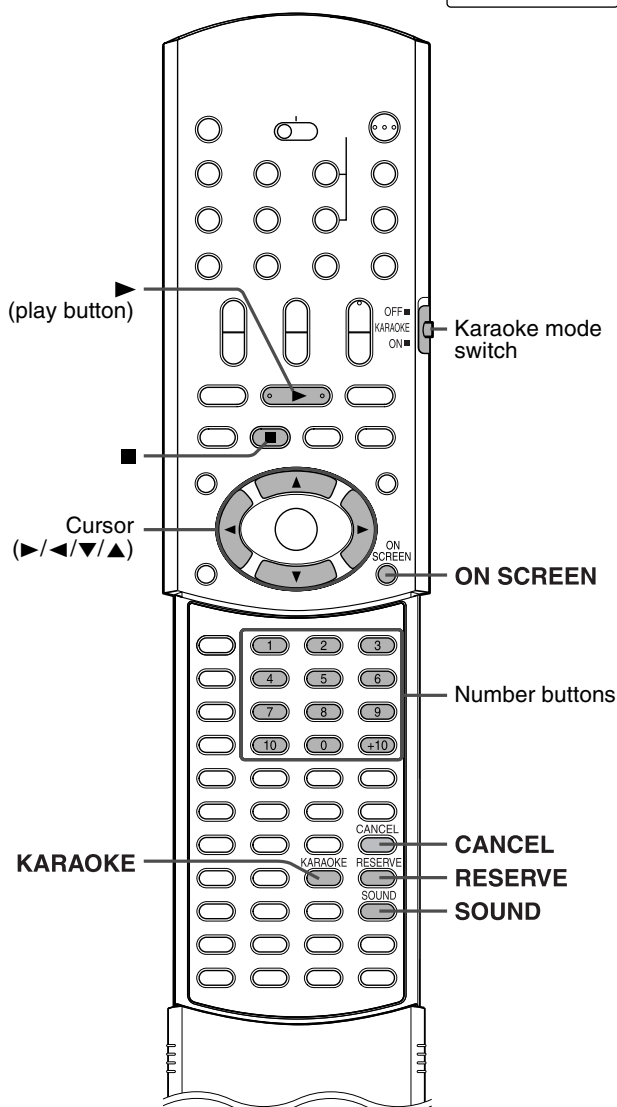
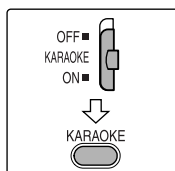

Reserving songs

You can reserve your desired songs (titles/tracks) to play in the order of your choice. Up to 12 songs can be reserved with this function.



1 Press RESERVE.

The reservation list appears on the TV screen. Up to six songs are listed at a time on the TV screen.

2 Press number buttons (1-10, +10) to select your desired song to reserve by specifying the disc and title/track numbers.

Example:

To specify "title/track 3" of "disc 3": Press 3 ⇒ 3

To specify "title/track 14" of "disc 3": Press 3 ⇒ +10 ⇒ 4

To specify "title/track 20" of "disc 3": Press 3 ⇒ +10 ⇒ 10

No	Disc	Track
1	3	3
2		
3		
4		
5		
6		

To erase a reserved song

Press Cursor ▼/▲ to move to the desired song (disc and title/track numbers), then press CANCEL.

To add a song to the reservation list

Press Cursor ▼/▲ to move to the desired song (disc and title/track numbers), then specify a new disc and title/track numbers. The new song is inserted before the selected song.

3 Repeat step 2 to reserve the rest of your selection.

4 Press ► (play button) to start playback of the reserved songs.

To hide or show the reservation list

Press RESERVE. Each time you press RESERVE, the reservation list disappears/appears from/on the TV screen.

To clear all reserved songs

While the reservation list is displayed, press ■ to stop playback, then press ■ again.

NOTE

- When "⊙" appears in step 2, 12 songs have already been reserved and you cannot make more reservations.
- While the reservation list is not displayed on the TV screen, you cannot start playback of the reserved songs by pressing ► (play button). Be sure to press RESERVE to display the reservation list before you start playback.

Selecting audio

Most Karaoke discs have the capability of adding “Guide vocal” or “Guide melody” to the Karaoke accompaniment.

Selecting audio channel(s) [AUDIO]

With most DVD Karaoke discs, you can select audio channel(s) among some options called “with guide vocal”, “with guide melody”, and “accompaniment only”, etc. to enjoy Karaoke to your preference.



■ During playback

1 Press ON SCREEN.

The Karaoke on-screen bar appears on the TV screen.

2 Press Cursor ▶/◀ repeatedly to move to “AUDIO”.



3 Press Cursor ▼/▲ repeatedly to select the desired audio channel.

Each time you press Cursor ▼/▲, audio channel changes as follows;

Example;

1/3 ⇄ 2/3 ⇄ 3/3 ⇄ (back to the beginning)

- 1/3: To listen to Multi audio Karaoke.
- 2/3: To listen to a song with guide vocal.
- 3/3: To listen to accompaniment only.

NOTE

- When “⊙” appears on the TV screen, the disc does not contain multi audio channels or this operation is prohibited.

Selecting Karaoke sound [KARAOKE SOUND]

When you play “Multi-sound Karaoke” discs, you can enjoy various sound options (channels).



For example, you can sing a duet with the other vocal part recorded on the disc. Note that this setting is applied only to the current disc.

■ During playback

When using the **SOUND** button:

1 Press SOUND.

The following pop-up window appears on the TV screen.

- Be sure to go to the next step within five seconds while the pop-up window is displayed on the TV screen.

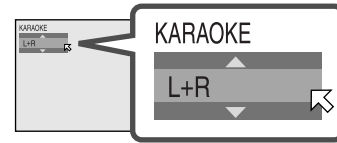

2 Press SOUND repeatedly to select the desired sound.

Each time you press SOUND, Karaoke sound changes as follows;

Example for a multi-sound DVD:

OFF ⇄ 1 ⇄ 2* ⇄ 1+2* ⇄ PRO ⇄ (back to the beginning)

- * Available only for a DVD containing duet vocal sound.
- OFF: To listen to a song with guide melody.
- 1: To listen to a song with guide vocal (1).
- 2: To listen to a song with guide vocal (2).
- 1+2: To listen to a song with guide vocal (1+2).
- PRO: To listen to accompaniment only.

NOTE

- When a DVD containing no “Multi-sound Karaoke” is played back, “L+R” appears on the TV screen. However the setting may not be changed.

Example for a video CD, super VCD, or an audio CD:

L+R ⇄ L ⇄ R ⇄ (back to the beginning)

- L+R: To listen to L (left) and R (right) audio channel.
- L: To listen to L (left) audio channel.
- R: To listen to R (right) audio channel.

When using the Karaoke on-screen bar:

1 Press ON SCREEN.

The Karaoke on-screen bar appears on the TV screen.

2 Press Cursor ▶/◀ repeatedly to move to “KARAOKE”.



3 Press Cursor ▼/▲ repeatedly to select the desired sound.

KARAOKE operations (TH-M65 only)

IMPORTANT

Before using the remote control for the following operation;

- 1 Set the Karaoke mode switch to ON.
- 2 Press KARAOKE button so that "KARAOKE" appears on the display window.

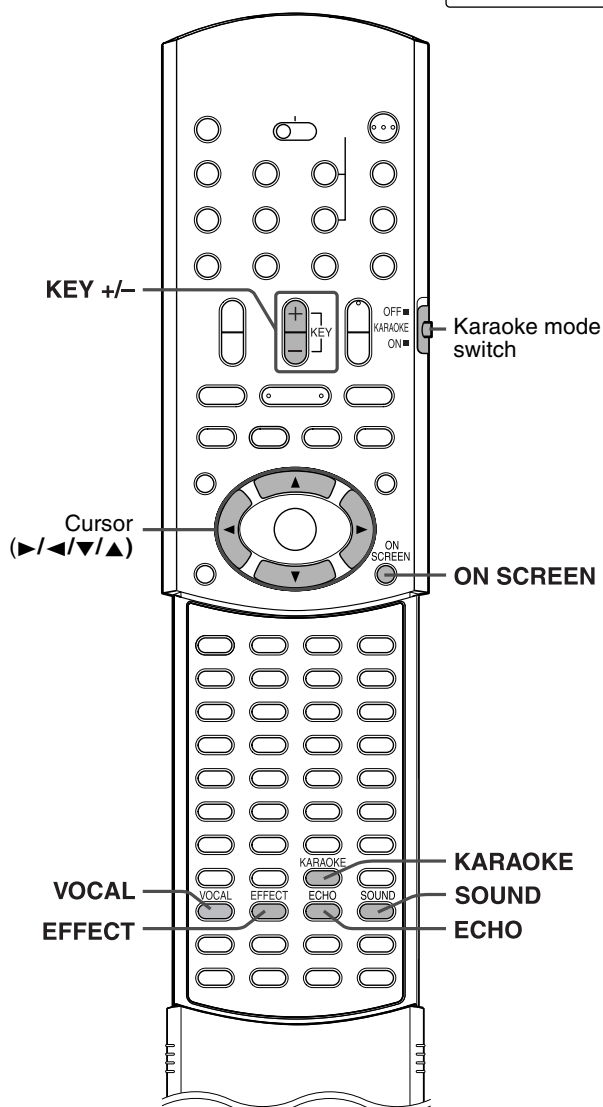
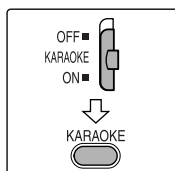

Masking the vocal recorded on a normal disc [VOCAL MASK]

You can enjoy Karaoke with a normal disc (containing no multiplex audio or multi-sound Karaoke audio, etc.) by



attenuating the frequencies around a human voice with this function. Note that this setting is applied only to the current disc.

NOTE

- Be sure to utilize KARAOKE SOUND function for a Karaoke discs containing multiplex audio or "Multi-sound Karaoke" audio, etc. (pg. 58)

- During playback

When using the VOCAL button:

1 Press VOCAL.

The following pop-up window appears on the TV screen.

- Be sure to go to the next step within five seconds while the pop-up window is displayed on the TV screen.

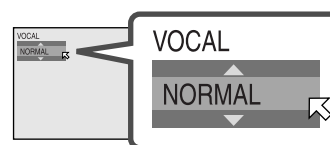

2 Press VOCAL repeatedly to select "MASK".

Each time you press VOCAL, vocal option changes as follows:

NORMAL ⇒ **MASK** ⇒ **REPLACE** ⇒ (back to the beginning)

When using the Karaoke on-screen bar:

1 Press ON SCREEN.

The Karaoke on-screen bar appears on the TV screen.

2 Press Cursor ►/◀ repeatedly to move to "VOCAL".

AUDIO	KARAOKE	VOCAL	ECHO	EFFECT	KEY CONT
1/3	L+R	NORMAL	OFF	OFF	0

3 Press Cursor ▼/▲ repeatedly to select "MASK".

To resume normal playback

Select "NORMAL" in the procedure above.

NOTE

- The voice may not be masked enough with some discs.
- When "KARAOKE SOUND" is set to "L" or "R", vocal mask function does not work correctly. In such a case, set "KARAOKE SOUND" to "L+R".

Resuming the masked vocal sound only when you stop singing [VOCAL REPLACE]

You may have experiences that you could not sing in the middle of Karaoke because you forgot the melody, etc. In such a case, use this function so that the masked vocal sound automatically resumes to replace your voice when you stop singing. It may be helpful for practicing Karaoke. Note that this setting is applied only to the current disc.



During playback

1 Set "KARAOKE SOUND" to appropriate sound option (channel). (pg. 58)

- For "Multi-sound Karaoke" discs, select "1", "2" or "1+2" to select a channel that contains guide vocal.
- For normal audio discs, select "L+R".
- For multiplex audio discs, select "L" or "R".

When using the VOCAL button:

2 Press VOCAL.

- The following pop-up window appears on the TV screen.
- Be sure to go to the next step within five seconds while the pop-up window is displayed on the TV screen.

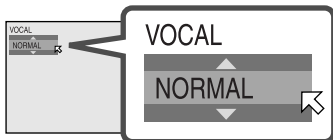

3 Press VOCAL repeatedly to select "REPLACE".

- Each time you press VOCAL, vocal option changes as follows:
NORMAL ⇒ **MASK** ⇒ **REPLACE** ⇒ (back to the beginning)

When using the Karaoke on-screen bar:

2 Press ON SCREEN.

The Karaoke on-screen bar appears on the TV screen.

3 Press Cursor ►/◀ repeatedly to move to "VOCAL".

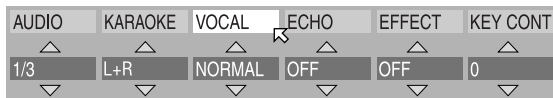

4 Press Cursor ▼/▲ repeatedly to select "REPLACE".

To resume normal playback

Select "NORMAL" in the procedure above.

Adding an effect to your voice

You can add 3 types of sound effect (ECHO, CHORUS, and FLANGER) to your voice.



Adding an echo effect

When using the ECHO button:

1 Press ECHO.

- The following pop-up window appears on the TV screen.
- Be sure to go to the next step within five seconds while the pop-up window is displayed on the TV screen.

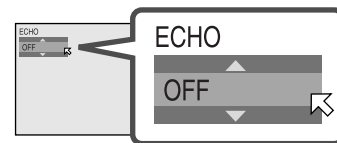

2 Press ECHO repeatedly to adjust the effect level.

- Each time you press ECHO, vocal option changes as follows:
OFF ⇒ **1** ⇒ **2** ⇒ **3** ⇒ (back to the beginning)
 As the number increases, the effect will be emphasized. (Normally set the level to "2".)

When using the Karaoke on-screen bar:

1 Press ON SCREEN.

The Karaoke on-screen bar appears on the TV screen.

2 Press Cursor ►/◀ repeatedly to move to "ECHO".

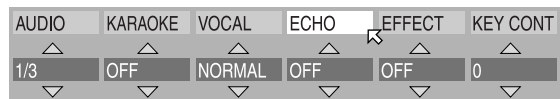

3 Press Cursor ▼/▲ repeatedly to adjust the effect level.

To cancel the sound effect

Select "OFF" in the procedure above.

NOTE

- You cannot apply the echo effect and the CHORUS/FLANGER effect (pg. 61) at the same time to your voice.

KARAOKE operations (TH-M65 only)

Adding sound effects to your voice

When using the **EFFECT** button:

1 Press **EFFECT**.

The following pop-up window appears on the TV screen.

- Be sure to go to the next step within five seconds while the pop-up window is displayed on the TV screen.

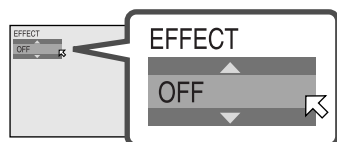

2 Press **EFFECT** repeatedly to select a sound effect option.

Each time you press **EFFECT**, vocal option changes as follows;

OFF ⇒ **CHORUS** ⇒ **FLANGER** ⇒ (back to the beginning)

- **CHORUS**: Produces a doubling effect on your voice as if another person sings in unison.
- **FLANGER**: Adds a wet, metallic sweeping sound to your voice, similar to some electric guitar sound.

When using the **Karaoke on-screen bar**:

1 Press **ON SCREEN**.

The Karaoke on-screen bar appears on the TV screen.

2 Press **Cursor** ▶/◀ repeatedly to move to “**EFFECT**”.



3 Press **Cursor** ▼/▲ repeatedly to select the desired sound effect.

To cancel the sound effect

Select “OFF” in the procedure above.

NOTE

- You cannot apply the CHORUS/FLANGER effect and the echo effect (pg. 60) at the same time to your voice.

Shifting the pitch of the playback sound

You can sharp/flat the pitch of a song recorded on a disc by a halftone interval to match your voice range. Note that this setting is applied only to the current title/track.



When using the **KEY+/-** buttons:

1 Press **KEY+/-**.

The following pop-up window appears on the TV screen.

- Be sure to go to the next step within five seconds while the pop-up window is displayed on the TV screen.

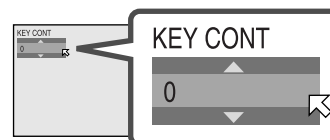

2 Press **KEY+/-** repeatedly to adjust the pitch (-4 to +4).

- Press **KEY+** to sharp and **KEY-** to flat the pitch.

When using the **Karaoke on-screen bar**:

1 Press **ON SCREEN**.

The Karaoke on-screen bar appears on the TV screen.

2 Press **Cursor** ▶/◀ repeatedly to move to “**KEY CONT**”.



3 Press **Cursor** ▼/▲ repeatedly to adjust the pitch (-4 to +4).

To resume normal playback

Select “0” in the procedure above.

NOTE

- Depending on the type of the recorded source (such as a DTS Digital Surround software, etc.), you may not be able to shift the pitch.

Maintenance

To get the best performance out of this system, keep your discs and mechanism clean.

■ General Notes

In general, you will have the best performance by keeping your discs and the mechanism clean.

- Store discs in their cases and keep them in cabinets or on shelves.

■ Handling Discs

- Remove the disc from its case by holding it at the edge while pressing the center hole lightly.
- Do not touch the shiny surface of the disc or bend the disc.
- Put the disc back in its case after use to prevent warping.
- Be careful not to scratch the surface of the disc when placing it back in its case.
- Avoid exposure to direct sunlight, temperature extremes and moisture.



To clean the disc

Wipe the disc with a soft cloth in a straight line from center to edge.

- **DO NOT use any solvent — such as conventional record cleaner, spray, thinner or benzine — to clean the disc.**



■ Cleaning the system

- Stains on the system should be wiped off with a soft cloth. If the system is heavily stained, wipe it with a cloth soaked in water-diluted neutral detergent and wrung well, then wipe clean with a dry cloth.
- Since the system may deteriorate in quality, become damaged or get its paint peeled off, be careful about the following.
 - DO NOT wipe it with a hard cloth.
 - DO NOT wipe it strong.
 - DO NOT wipe it with thinner or benzine.
 - DO NOT apply any volatile substance such as insecticides to it.
 - DO NOT allow any rubber or plastic to remain in contact with it for a long time.

Trouble shooting

Use this chart to help you solve daily operational problems. If there is any problem you cannot solve, contact your JVC service center.

General

PROBLEM	POSSIBLE CAUSE	SOLUTION
Power does not come on.	The power cord is not connected to the center unit or an AC outlet.	Connect the power cord correctly. (☞ pg. 15)
Power is not supplied to the powered subwoofer.	The power cord of the subwoofer is not connected to an AC outlet.	Turn off the system, plug the power cord firmly into an AC outlet, and turn on the system again. (☞ pg. 15, 19)
	The system cord is not connected.	Connect the system cord. (☞ pg. 10)
The system does not work correctly.	Lightning or electronic noise interferes with operation of the microcomputer.	Switch the power off, then disconnect/reconnect the power plug.
	Immediately after beginning to heat the room, the system was moved to a cold location causing condensation to form inside.	Switch the power off and leave the system a few hours before switching the power on again.
The remote control does not work.	It is too far from the center unit, or is not facing the center unit.	Move closer to the center unit. (Operate the remote control within 7 m of the center unit.) (☞ pg. 16)
	There is something obstructing the remote sensor.	Remove any obstacles. (☞ pg. 16)
	The remote control is not aimed at the remote sensor on the center unit or components.	Aim the remote control at the remote sensor on the equipment you want to operate. (☞ pg. 16)
	The remote control mode selector is set at an incorrect position.	Set the selector to the correct position. (☞ pg. 19)
	The batteries are exhausted.	Replace the batteries. (☞ pg. 16)
	The batteries have been inserted the wrong way round (+/-).	Insert the batteries correctly. (☞ pg. 16)
	The remote control is not set to operate the DVD player or tuner (FM/AM).	For the DVD player, press DVD before you perform the operations. (☞ pg. 23) For the tuner, press FM/AM before you perform the operations. (☞ pg. 27)
	Sunlight is falling directly on the remote sensor.	Hide the remote sensor from direct sunlight.
The remote control signals are not set correctly.	Enter the correct manufacturer's code. (☞ pg. 17, 18)	

Continued on next page

References

PROBLEM	POSSIBLE CAUSE	SOLUTION
No sound.	The system cord and/or speaker cord is not connected.	Check the connection. (☞ pg. 10 – 13)
	There is a short in the speaker cord.	Reconnect the speaker cord.
	The audio cord is not connected to AUDIO IN (VCR) and/or DIGITAL IN (DBS) correctly.	Connect the cord correctly. (☞ pg. 14)
	An incorrect source has been selected.	Select the correct source. (☞ pg. 20)
	Muting is on.	Press MUTING to cancel muting. (☞ pg. 20)
	The decode mode is not set correctly.	Select the proper decode mode. (☞ pg. 22)
Sound from one front speaker only.	The speaker cord is not connected correctly.	Connect the speaker cord correctly. (☞ pg. 10)
	Left-right balance is not set properly.	Adjust the balance properly. (☞ pg. 49, 54)
No sound from the center and/or surround speakers.	The speaker setting is incorrect.	Set the speaker setting properly. (☞ pg. 50, 54)
Bass sound is heard reinforced when listening in stereo.	Appropriate bass level for stereo sound is not selected.	Set “AUDIO POS” properly. (☞ pg. 54)

DVD Playback

PROBLEM	POSSIBLE CAUSE	SOLUTION
No picture is displayed on the TV screen.	The video cord is not connected correctly.	Connect the cord correctly. (☞ pg. 8)
	TV input selection is incorrect.	Select the correct input on the TV.
	The disc is not playable.	Use a playable disc. (☞ pg. 3)
No picture is displayed on the TV screen, the picture is blurred, or the picture is divided into two parts.	The scan mode is set to “PROGRESSIVE” though the center unit is connected to the TV which does not support the progressive video input such as a conventional TV.	Change the scan mode to “INTERLACE”. (☞ pg. 22)
A disc cannot be played.	The center unit’s and disc’s Region Code numbers are incompatible.	Replace the disc. (☞ pg. 3)
	Parental Lock is in use.	Enter password to change the Parental Lock level. (☞ pg. 51)
A disc cannot be played and “0:00” is displayed on the display window.	The disc is loaded with its label and data sides inverted.	Load the disc correctly. (☞ pg. 23)
	The unplayable disc is loaded.	Replace the disc. (☞ pg. 3)
Video and audio are distorted.	The disc is scratched or dirty.	Replace or clean the disc. (☞ pg. 2)
	A VCR is connected between the center unit and the TV.	Connect the center unit and TV directly. (☞ pg. 8)
	With some discs, a picture may be blurred when setting “PICTURE SOURCE” to “FILM” or “AUTO”.	Set “PICTURE SOURCE” to “VIDEO (NORMAL)” or “VIDEO (ACTIVE)”. (☞ pg. 49)
The picture does not fit the TV screen.	The monitor type is not set correctly.	Set “MONITOR TYPE” properly. (☞ pg. 49)
	The TV is not set correctly.	Set the TV properly.
No subtitle appears on the TV screen though you have selected a certain language as your initial subtitle language.	—	Some DVDs are programmed to always display no subtitle initially. If this happens, press SUBTITLE on the remote control after starting play. (☞ pg. 39)
Audio language is different from the one you have selected as your initial audio language.	—	Some DVDs are programmed to always use the original language initially. If this happens, press AUDIO on the remote control after starting play. (☞ pg. 39)

References

MP3 Playback

PROBLEM	POSSIBLE CAUSE	SOLUTION
A disc cannot be played.	No MP3 files are recorded to the disc.	Replace the disc.
	MP3 files do not have the file extension in their file names.	Add correct file extension (.mp3, .Mp3, .mP3 or .MP3) to their file names. (☞ pg. 3)
	MP3 files are not recorded in a format compliant with ISO 9660 Level 1 or 2.	Replace the disc. (Record MP3 files using a compliant application.)
	The different types of files are recorded to the disc.	The disc which contains the different types of files may not be played because of its disc characteristics or recording conditions.
Not MP3 files but JPEG files are played.	The MP3/JPEG setting is set to “JPEG”.	When both MP3 files and JPEG files are recorded to a disc, set “MP3/JPEG” to “MP3” to play MP3 files. (☞ pg. 49)
The MP3 control display appears on the TV screen, but no operation can be performed.	No MP3 files or JPEG files are recorded to the disc, or the disc is an unplayable disc (such as CD-ROM).	Replace the disc. (☞ pg. 3)

JPEG Playback

PROBLEM	POSSIBLE CAUSE	SOLUTION
A disc cannot be played.	No JPEG files are recorded to the disc.	Replace the disc.
	JPEG files do not have the correct file extension in their file names.	Add correct file extension (.jpg, .jpeg, .JPG, .JPEG or any uppercase and lowercase combination such as “.Jpg”) to their file names. (☞ pg. 3)
	JPEG files are not recorded in a format compliant with ISO 9660 Level 1 or 2.	Replace the disc. (Record JPEG files using a compliant application.)
Not JPEG files but MP3 files are played.	The MP3/JPEG setting is set to “MP3”.	When both MP3 files and JPEG files are recorded to a disc, set “MP3/JPEG” to “JPEG” to play JPEG files. (☞ pg. 49)

FM/AM

PROBLEM	POSSIBLE CAUSE	SOLUTION
Hard to listen to broadcast because of noise.	Antennas are disconnected.	Reconnect the antennas correctly and securely.
	The AM loop antenna is too close to the center unit.	Change the position and direction of the AM loop antenna.
	The supplied FM antenna is not properly extended and positioned.	Extend the FM antenna to the best position.
	Beat Cut mode is not set properly while listening to an AM broadcast.	Try to change the Beat Cut mode. (☞ pg. 28)
Continuous static during FM broadcasts.	The received signal is too weak.	Connect an external FM antenna (☞ pg. 9), or contact your dealer.
	The station is too far away.	Select another station.

Others

PROBLEM	POSSIBLE CAUSE	SOLUTION
One-touch DVD play does not work though you have connected AV COMPU LINK cord correctly.	The video output jack type to watch the DVD playback is not set correctly.	Set “M. OUT” properly to watch the DVD playback. (☞ pg. 54)
The system suddenly turns off by itself.	The Sleep Timer or Auto Standby function is activated.	Turn the functions off. (☞ pg. 21, 51)

NOTE

- Problems may be caused by components connected to the center unit, so also read all manuals for the connected components carefully.

Glossary

Aspect ratio

The ratio of vertical and horizontal sizes of a displayed image. The horizontal vs. vertical ratio of conventional TVs is 4:3, and that of wide-screens is 16:9.

Chapter

Refers to individual chapters included in a title.

Composite video signal

Refers to video signal comprised of three kinds of signals combined: an image signal made up of luminance and chrominance signals using the frequency multiplication technique; burst signal providing the basis for color reproduction; and synchronization signal.

Component video signal

A video signal system where parts of information necessary for reproducing image signal comprised of the three primary colors of light are transmitted via separate signal lines. Types of signal, such as R/G/B, Y/Pb/Pr, etc., are available.

Disc menu

A screen display prepared for allowing selection of images, sounds, subtitles, multiangles, etc. recorded on a DVD.

Interlaced scan

In the conventional video system, a picture is shown on the display monitor in two halves. The Interlaced scan system places lines of the second half of the picture in-between lines of the first half of the picture.

JPEG

A still-picture data compression system proposed by the Joint Photographic Expert Group, which features small decrease in image quality in spite of its high compression ratio.

Letter box

A method of displaying wide images like movies in the center of a 4:3 TV screen with no part of the image deleted, by placing black bands on the top and bottom of the screen. This name has resulted from the screen form looking literally like a letter box.

Linear PCM (PCM: Pulse Code Modulation)

A system for converting analog sound signal to digital signal for later processing, with no data compression used in conversion.

MP3

A file format with a sound data compression system. "MP3" is the abbreviation of Motion Picture Experts Group 1 (or MPEG-1) Audio Layer 3. By using MP3 format, one CD-R or CD-RW can contain about 10 times as much data volume as a regular CD can.

Multiangle

By recording multiple scenes progressing at the same time in a single title, the user can select view angles. This feature is called the multiangle function.

Multichannel

DVD is specified to have each sound track constitute one sound field. Multichannel refers to a structure of sound tracks having three or more channels.

Multilanguage

When a title is created to cope with multiple languages, it is generally called a multilanguage title.

Parental Lock

A feature of this system to automatically determine whether or not to reproduce particular DVD software by comparing its parental level (a measure of undesirability of scenes, etc. from educational viewpoint) set for the software beforehand with that set on this system by the user; if the software's level is less restrictive than the user-set level, it will be reproduced.

Playback control (PBC)

Refers to the signal recorded on video CDs or SVCDs for controlling reproduction. By using menu screens recorded on a Video CD or SVCD that supports PBC, you can enjoy interactive-type software as well as software having a search function.

Progressive scan

Progressive scan displays all the horizontal lines of a picture at one time, as a single frame. This system can convert the interlaced video from DVD into progressive format for connection to a progressive display. It dramatically increases the vertical resolution.

Region Code

A system for allowing discs to be played back only in the regions designated beforehand. All the countries in the world are divided into six regions, each region being identified by a specified Region Code (or region number). If the Region Code given to a disc includes a numeral which matches one in the Region Code of a player, the player can play back the disc.

Sampling frequency

Frequency of sampling data when analog data is converted to digital data. Sampling frequency numerically represents how many times the original analog signal is sampled per second.

Surround

A system for creating three-dimensional sound fields full of realism by arranging multiple speakers around the listener.

Transfer rate

The rate of transferring digital data. Usually the measure is in baud per second. The DVD system applies a variable transfer rate system for high efficiency.

Index

- A**
- A-B Repeat Playback 45
 - All Channel Stereo (ALL CH ST.) 30 – 32
 - Angle 38
 - Audio CD 3, 4
 - Audio language (AUDIO LANGUAGE) 39, 48
 - Auto standby (AUTO STANDBY) 51
 - AUTO/PCM 22
 - AV COMPU LINK 55
- B**
- Bass (BASS) 21, 49
 - Beat cut mode (BEAT CUT) 28
- C**
- CD-R 3
 - CD-RW 3
 - Chapter 4
 - Choice menu 46 – 52
 - Audio menu (AUDIO) 49
 - Distance menu (DISTANCE) 50
 - Language menu (LANGUAGE) 48
 - Level menu (LEVEL) 50
 - Other setting menu (OTHERS) 51
 - Picture menu (PICTURE) 49
 - Size menu (SIZE) 50
 - Speaker setting menu (SPK. SETTING) 50
 - Component video 8
 - Composite video 8, 14
 - Crossover (CROSS OVER) 50, 54
- D**
- DAP (Digital Acoustic Processor) mode 29 – 32
 - Dance club (DANCE CLUB) 29 – 32
 - Hall (HALL) 29 – 32
 - Live club (LIVE CLUB) 29 – 32
 - Pavilion (PAVILION) 29 – 32
 - Decode mode 22
 - Dimmer 20
 - Dolby Digital 29 – 31
 - Dolby Pro Logic II 29 – 31
 - Pro Logic II Movie (PL II MOVIE) 29 – 31
 - Pro Logic II Music (PL II MUSIC) 29 – 31
 - DSP mode 29 – 32
 - DTS Digital Surround 29 – 31
 - DVD Video (DVD) 3, 4
 - Dynamic range compression (D.RANGE COMPRESSION) 49, 54
- F**
- Frame-by-frame playback 41
- G**
- Group 4
- I**
- Interlace mode (INTERLACE) 22
- J**
- JPEG 3, 4, 37
- K**
- KARAOKE 56
- L**
- Left/Right speaker balance (L/R BALANCE) 49, 54
 - Low frequency effect attenuater (LFE ATT.) 49, 54
- M**
- Menu language (MENU LANGUAGE) 48
 - Monitor type (MONITOR TYPE) 49
 - 16:9 AUTO 49
 - 16:9 NORMAL 49
 - 4:3 LB 49
 - 4:3 PS 49
 - MP3 3, 4, 36
 - Muting 20
- O**
- On-screen bar 33
 - On-screen guide icons (ON SCREEN GUIDE) 24, 51
 - On-screen language (ON SCREEN LANGUAGE) 48
- P**
- Parental Lock (PARENTAL LOCK) 51
 - Picture source (PICTURE SOURCE) 49
 - Playback Control function (PBC) 4, 35
 - Program Playback (PROGRAM) 43
 - Progressive mode (PROGRESSIVE) 22
- R**
- Random Playback 44
 - Region Code 3, 19
 - Repeat Playback 44
 - Resume Playback (RESUME) 24, 51
- S**
- Screen saver (SCREEN SAVER) 24, 49
 - Sleep Timer 21
 - Slow-motion 41
 - Subtitle language (SUBTITLE) 39, 48
 - Super Video CD (SVCD) 3, 4
 - Surround mode 29 – 32
 - S-video 8, 14
- T**
- Test tone (TEST TONE) 32, 50
 - Title 4
 - Track 4
 - Tray lock 25
 - Treble (TREBLE) 21, 49
- V**
- Video CD (VCD) 3, 4
 - Video Fine Processor (VFP) 42
- Z**
- Zoom 41

Specifications

■ Center unit (XV-THM65/XV-THM45)

Audio section

Total Harmonic Distortion 0.02 %

NOTE: This value is measured at System cord CONNECTOR for reference.

Audio input sensitivity/Impedance (at 1 kHz)

Analog input:

AUDIO IN (VCR): 290 mV/47 k Ω

MIC (XV-THM65 only):

4.3 mV/600 Ω

Digital input*:

DIGITAL IN (DBS): -21 dBm to -15 dBm

(OPTICAL) (660 nm \pm 30 nm)

* Corresponding to Linear PCM, Dolby Digital, and DTS Digital Surround (with sampling frequency — 32 kHz, 44.1 kHz, 48 kHz)

Digital output (XV-THM65 only):

DIGITAL OUT: -21 dBm to -15 dBm

(OPTICAL) (660 nm \pm 30 nm)

Video section

Color System: NTSC/PAL selectable

Horizontal Resolution: 500 lines

Signal-to-Noise Ratio: 64 dB

Video output level

Composite: 1.0 V(p-p)/75 Ω

S-video-Y: 1.0 V(p-p)/75 Ω

S-video-C: 0.286 V(p-p)/75 Ω

Component-Y: 1.0 V(p-p)/75 Ω

Component-Pb/Pr: 0.7 V(p-p)/75 Ω

Video input sensitivity/Impedance (VCR IN)

Composite: 1.0 V(p-p)/75 Ω

S-video-Y: 1.0 V(p-p)/75 Ω

S-video-C: 0.286 V(p-p)/75 Ω

Tuner section

Tuning Range

FM: 87.50 MHz to 108.00 MHz

AM: 531 kHz to 1 602 kHz

(at 9 kHz intervals)

530 kHz to 1 600 kHz

(at 10 kHz intervals)

General

Power Requirements: AC 110 – 230 V \sim ,
50 Hz/60 Hz

Power Consumption: 20 W (at operation)
1.6 W (in standby mode)

Dimensions (W \times H \times D): 400 mm \times 85 mm \times 386 mm

Mass: 4.6 kg

■ Subwoofer (SP-PWM65)

Amplifier section

Front/Center/Surround: 80 W per channel, RMS at 6 Ω at
1 kHz, with 10 % total harmonic
distortion.

Subwoofer: 120 W, RMS at 4 Ω at 100 Hz, with
10 % total harmonic distortion.

Speaker section

Speaker unit: 20 cm Bass-reflex, Magnetically
Shielded

Frequency Range: 25 Hz to 200 Hz

General

Power Requirements: AC 110 V/127 V/220 – 230 V \sim
selectable with the voltage selector,
50 Hz/60 Hz

Power Consumption: 150 W (at operation)
0 W (in standby mode)

Dimensions (W \times H \times D): 235 mm \times 355 mm \times 492 mm

Mass: 13.0 kg

■ Subwoofer (SP-PWM45)

Amplifier section

Front/Center/Surround: 80 W per channel, RMS at 6 Ω at
1 kHz, with 10 % total harmonic
distortion.

Subwoofer: 120 W, RMS at 4 Ω at 100 Hz, with
10 % total harmonic distortion.

Speaker section

Speaker unit: 16 cm Bass-reflex, Magnetically
Shielded

Frequency Range: 30 Hz to 200 Hz

General

Power Requirements: AC 110 V/127 V/220 – 230 V \sim
selectable with the voltage selector,
50 Hz/60 Hz

Power Consumption: 140 W (at operation)
0 W (in standby mode)

Dimensions (W \times H \times D): 216 mm \times 353 mm \times 485 mm

Mass: 12.0 kg

References

■ Satellite Speakers (SP-THM65F)

Speakers: 5.5 cm × 2
Bass-reflex, Magnetically Shielded
Power Handling Capacity: 80 W
Impedance: 6 Ω
Frequency Range: 90 Hz to 20 kHz
Dimensions (W × H × D): 250 mm × 103 mm × 250 mm
Mass: 3.77 kg

■ Center Speaker (SP-THM65C)

Speakers: 5.5 cm × 2
Bass-reflex, Magnetically Shielded
Power Handling Capacity: 80 W
Impedance: 6 Ω
Frequency Range: 90 Hz to 20 kHz
Dimensions (W × H × D): 258 mm × 75 mm × 81 mm
Mass: 0.95 kg

■ Satellite Speakers

Front speakers (SP-THM45F)

Speakers: 8.0 cm
Bass-reflex, Magnetically Shielded
Power Handling Capacity: 80 W
Impedance: 6 Ω
Frequency Range: 90 Hz to 20 kHz
Dimensions (W × H × D): 103 mm × 115 mm × 100 mm
Mass: 0.64 kg

Surround speakers (SP-THM45S)

Speakers: 8.0 cm
Bass-reflex, Magnetically Shielded
Power Handling Capacity: 80 W
Impedance: 6 Ω
Frequency Range: 90 Hz to 20 kHz
Dimensions (W × H × D): 103 mm × 115 mm × 100 mm
Mass: 0.52 kg

■ Center Speaker (SP-THM45C)

Speakers: 8.0 cm
Bass-reflex, Magnetically Shielded
Power Handling Capacity: 80 W
Impedance: 6 Ω
Frequency Range: 90 Hz to 20 kHz
Dimensions (W × H × D): 103 mm × 115 mm × 100 mm
Mass: 0.64 kg

■ Accessories

- Remote control (1)
- Batteries (2)
- FM antenna (1)
- AM loop antenna (1)
- Power cord (1)
- System cord (1)
- Composite video cord (1)
- Speaker cords
 - 5 m: For satellite (front left/right) and center speakers (3)
 - 10 m: For satellite speakers (surround left/right) (2)
 - (The length of the above speaker cords are approximate.)
- Screws (with washer) (TH-M65 only)
 - M4 x 25 mm: For the satellite speakers (16)
- AC plug adaptor (2)

Designs & specifications are subject to change without notice.

Mains (AC) Line Instruction (not applicable for Europe, U.S.A., Canada, Australia and U.K.)

Instrucción sobre la línea de la red (CA) (no aplicable para Europa, EE.UU., Canadá, Australia, ni el Reino Unido)

Instrução sobre a tensão da rede eléctrica (CA) (não aplicável para a Europa, os E.U.A., o Canadá, a Austrália e o Reino Unido)

SP-PWM65
SP-PWM45

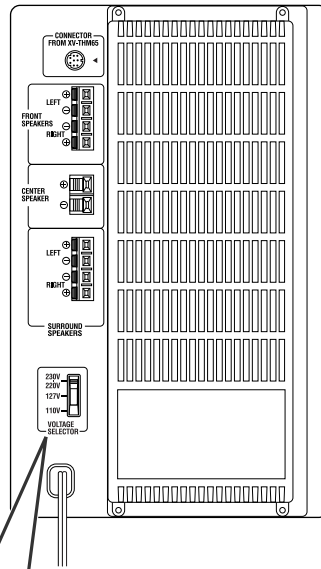

CAUTION for mains (AC) line

BEFORE PLUGGING IN, do check that your mains (AC) line voltage corresponds with the position of the voltage selector switch provided on the outside of this equipment and, if different, reset the voltage selector switch, to prevent from a damage or risk of fire/electric shock.

PRECAUCIÓN para la línea de la red (CA)

ANTES DE ENCHUFAR EL EQUIPO, compruebe si la tensión de la línea de la red (CA) corresponde con la posición del selector de tensión situado en la parte exterior del equipo, y si es diferente, reajuste el selector de tensión para evitar el riesgo de incendios/ descargas eléctricas.

PRECAUÇÃO para a ligação à tensão da rede (CA)

ANTES DE LIGAR O APARELHO A UMA TOMADA DA REDE, verifique se a tensão da rede CA corresponde à posição do selector de voltagem localizado na parte externa deste equipamento. Caso não corresponda, reajuste o selector de voltagem a fim de evitar avarias ou riscos de incêndio e choque eléctrico.

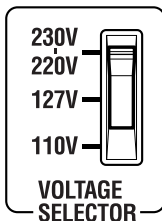

JVC

VICTOR COMPANY OF JAPAN, LIMITED

